



ESPADAN PUMP

صنایع الکترو پمپ سازی

اسپادان



کاتالوگ راهنمای انتخاب پمپ شناور فولادی ضد زنگ

Stainless Steel Submersible Pump

گواهینامه کیفیت

TUV NORD

CERTIFICATE

Management of Customer Complaint Handling Process
as per ISO 10002: 2004

In accordance with TÜV NORD Iran procedures, it is hereby certified that

ESPADAN PUMP Co.
Industrial City 2 of Najaf Abad, Isfahan, Iran



applies a management system in line with the above standard for the following scope

Design, Manufacturing Various Kinds of Industrial Agricultural, Water Supplying Pumps and Submersible Electro-Motors

Certificate Registration No. IR 10002 149342 Valid until 2016-10-28
Audit Report No. 10002 IR 0151



Tehran, 2004-10-29

This Certification was conducted in accordance with the TÜV NORD Iran auditing and certification procedures and is subject to regular surveillance audits.

TÜV NORD Iran Industrial City 2 of Najaf Abad, Amir Kabir Avenue, accessory side 22, Isfahan, Iran

TUV NORD

CERTIFICATE

Management system as per
ISO 14001: 2004

In accordance with TÜV NORD Iran procedures, it is hereby certified that

ESPADAN PUMP Co.
Najaf Abad, Amir Kabir Avenue, Isfahan, Iran



applies a management system in line with the above standard for the following scope

Design, Manufacturing and Assembling Different Kinds of Industrial Agricultural, Water Supply, Oil and Submersible Electro-Motors

Certificate Registration No. IR 104 150016 Valid until 2017-07-05
Audit Report No. 104 IR 0151



Tehran, 2004-07-06

This Certification was conducted in accordance with the TÜV NORD Iran auditing and certification procedures and is subject to regular surveillance audits.

TÜV NORD Iran Industrial City 2 of Najaf Abad, Amir Kabir Avenue, accessory side 22, Isfahan, Iran

TUV NORD

CERTIFICATE

Management system as per
OHSAS 18001: 2007

In accordance with TÜV NORD Iran procedures, it is hereby certified that

ESPADAN PUMP Co.
Najaf Abad, Amir Kabir Avenue, Isfahan, Iran



applies a management system in line with the above standard for the following scope

Design, Manufacturing and Assembling Different Kinds of Industrial Agricultural, Water Supply, Oil and Submersible Electro-Motors

Certificate Registration No. IR 116 150014 Valid until 2017-09-20
Audit Report No. 116 IR 0151



Tehran, 2007-09-21

This Certification was conducted in accordance with the TÜV NORD Iran auditing and certification procedures and is subject to regular surveillance audits.

TÜV NORD Iran Industrial City 2 of Najaf Abad, Amir Kabir Avenue, accessory side 22, Isfahan, Iran

TUV NORD

CERTIFICATE

Management system as per
ISO 9001: 2008

In accordance with TÜV NORD Iran procedures, it is hereby certified that

ESPADAN PUMP Co.
Industrial City 2 of Najaf Abad, Amir Kabir Avenue
accessory side 22, Isfahan, Iran



applies a management system in line with the above standard for the following scope

Design, Manufacturing and Assembling Different Kinds of Industrial Agricultural, Water Supply, Oil and Submersible Electro-Motors

Certificate Registration No. IR 100 150713 Valid until 2016-03-21
Audit Report No. 100 IR 0151



Tehran, 2006-02-01

This Certification was conducted in accordance with the TÜV NORD Iran auditing and certification procedures and is subject to regular surveillance audits.

TÜV NORD Iran Industrial City 2 of Najaf Abad, Amir Kabir Avenue, accessory side 22, Isfahan, Iran



درباره ما

صنایع الکتروپمپ سازی اسپادان با هدف تولید الکتروپمپ های شناور در سال ۱۳۸۹ با یک واحد صنعتی به مساحت ۱۲۵۰۰ متر تاسیس شد و در سال ۱۳۹۳ با ثبت علامت تجاری صنایع الکتروپمپ سازی اسپادان به شماره ۳۱۵۸۸ و پروانه بهره برداری از وزارت صنایع به شماره ۱۱۶۹۴/۱۰۴ در زمینه ساخت پمپ های شناور طرح RITS و kSB با کیفیت رقابتی و با کادری مجرب و متخصص اقدام به راه اندازی خط تولید الکتروپمپ های شناور، پمپ های فشار قوی و پمپ های گریز از مرکز با استانداردهای روز دنیا نموده است.

این شرکت هم اکنون با تولید محصولات پمپ های فشار قوی (High Pressure Pump) و پمپ های گریز از مرکز (Centrifugal Pump) و پمپ شناور (Submersible Pump) جزء یکی از تولیدکنندگان انواع سیستم پمپاژ در ایران می باشد.

به علت طراحی کارآمد پمپ های شناور (۴،۶،۸) اینچ این پمپ ها دارای تعداد طبقات کمتری هستند. در نتیجه دارای طول عمر بیشتر و کارکرد بدون مشکل می باشند.

مشخصات و مزایای پمپ:

- ۱- قسمت ورودی ، پوسته طبقات و همچنین خروجی از جنس فولاد ضد زنگ می باشد.
- ۱- پروانه ها از فولاد ضد زنگ ساخته شده است.
- ۳- شافت پمپ از جنس فولاد ۴۳۱ می باشد.
- ۴- بوش یاتاقان شفت برای مقاومت در برابر شن و ماسه از جنس لاستیک ضد سایش می باشد.
- ۵- شیر یک طرفه از جنس فولاد ضد زنگ می باشد.
- ۶- محافظ کابل و صافی از جنس فولاد ضد زنگ می باشد.
- ۷- کوپلینگ پمپ و موتور مطابق با استاندارد NEMA می باشد.
- ۸- حداقل عمق آب مکش ۱ متری می باشد.
- ۹- حداکثر میزان شن و ماسه ۵۰ گرم بر متر مکعب می باشد.
- ۱۰- کاربرد: این پمپ ها برای مصارف خانگی ، کشاورزی ، صنعتی می باشد.

۱۱- محدوده کاری :

پمپ شناور ۴ اینچ :

محدوده ارتفاع: از ۹ متر تا ۵۱۰ متر

دبی (ظرفیت آبدهی): از ۷ تا ۱۸۵ لیتر بر دقیقه

غوطه وری : حداقل ۱ متر

پمپ شناور ۶ اینچ :

محدوده ارتفاع: از ۴ متر تا ۴۸۹ متر

دبی (ظرفیت آبدهی): از ۷۰ تا ۱۳۰۰ لیتر بر دقیقه

غوطه وری : حداقل ۱ متر

پمپ شناور ۸ اینچ :

محدوده ارتفاع: از ۷ متر تا ۳۹۵ متر

دبی (ظرفیت آبدهی): از ۳۳۵ تا ۲۰۰۰ متر

غوطه وری : حداقل ۱ متر



جدول مشخصات پمپ سری 3 ESP 4

No.	PART NAME	MATERIAL
1	N.R.V. 1.25"	S.S.304
2	VALVE	S.S.304
3	VALVE SEAT	N.B.R.
4	TOP BEARING HOUSING	S.S.304
5	TOP BEARING HOUSING BUSH	N.B.R.
6	TOP BEARING HOUSING SLEEVE	S.S.304
7	THRUST WASHER	S.S.304
8	TOP DIFFUSER	S.S.304
9	DIFFUSER	S.S.304
10	BEARING BUSH	N.B.R.
11	NECKRING	N.B.R. + P.P.S.
12	IMPELLER	S.S.304
13	STAGE SLEEVE	S.S.304
14	MIDDLE BEARING HOUSING	S.S.304
15	MIDDLE BEARING HOUSING BUSH	N.B.R. + S.S.304
16	MIDDLE BEARING HOUSING SLEEVE	S.S.304
17	PUMP SHAFT	S.S.431
18	FIRST STAGE DIFFUSER	S.S.304
19	PRIMING SCREW	S.S.304
20	STRAINER	S.S.304
21	NEMA COUPLING	S.S.304
22	SUCTION INTERCONNECTOR	S.S.304
23	CLAMPING STRIP	S.S.304
24	HEX NUT	S.S.316
25	CABLE GUARD	S.S.304

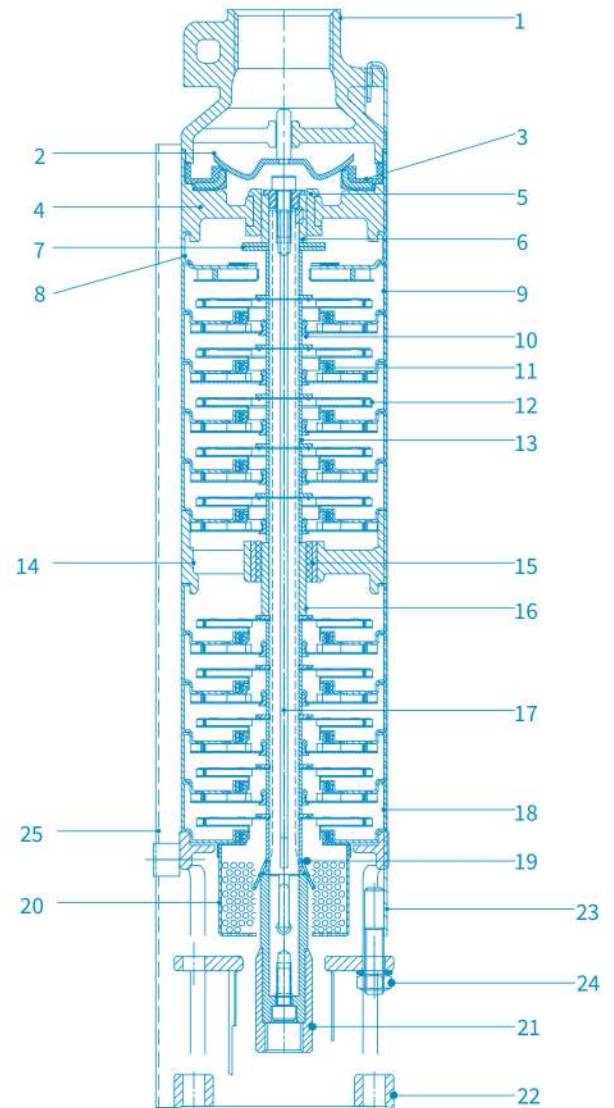

منحنی های عملکرد پمپ سری 3 ESP 4

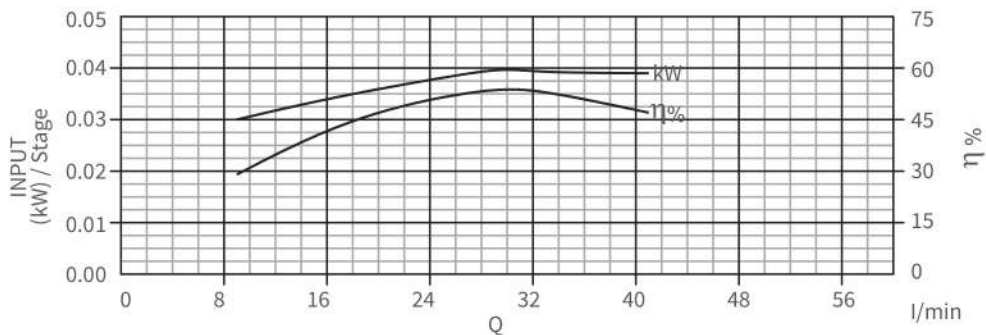
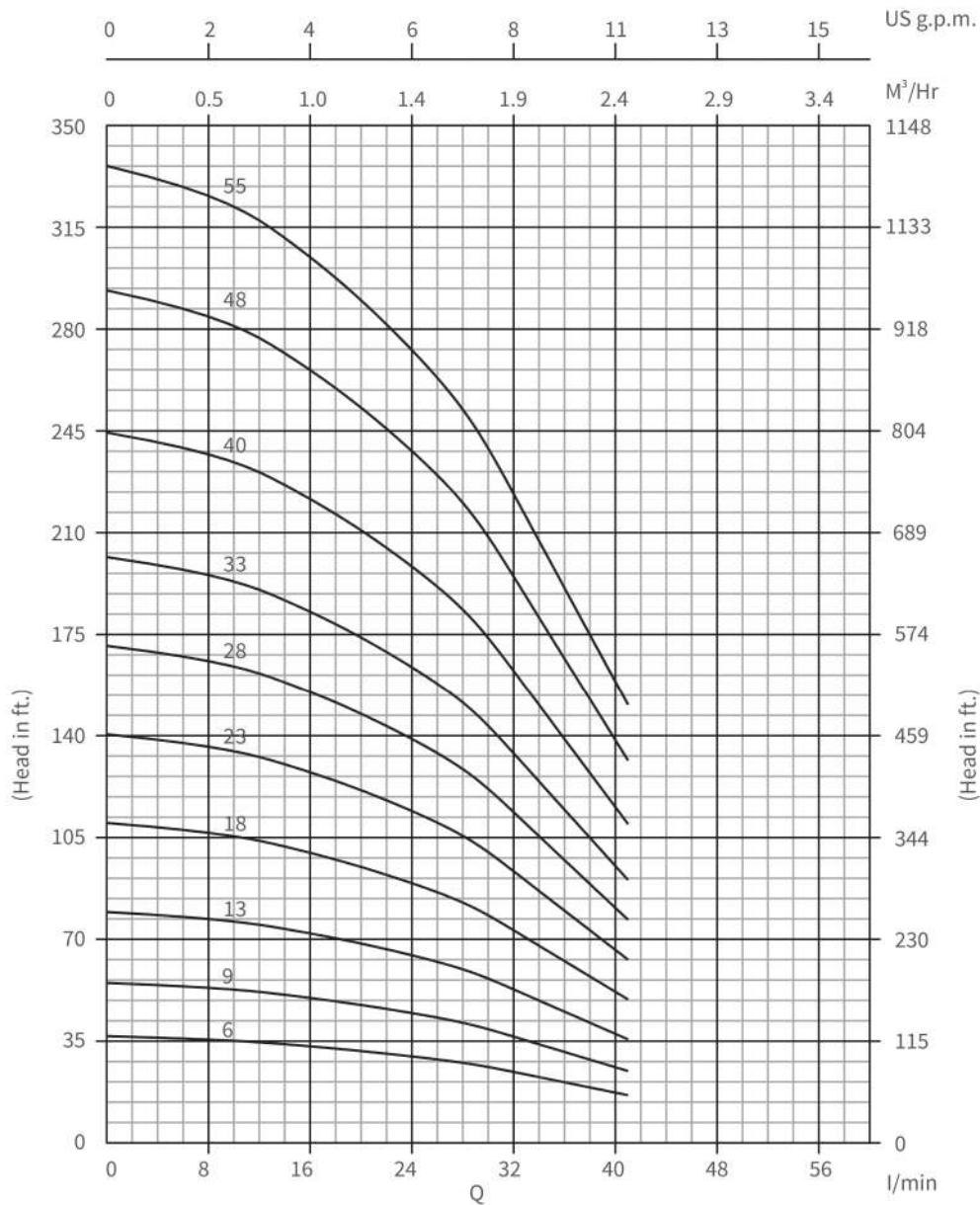

جدول عملکرد پمپ سری 3 ESP 4

Model Name		Stage	Rating		l/min m ³ /h	Discharge						
Single Phase	Three Phase		kW	HP		0	9	14	20	27	30	33

4 ESP 3-06	4 ESP 3-06	6	0.37	0.50	HEAD IN MTRS.	37	36	34	32	28	26	23	16
4 ESP 3-09	4 ESP 3-09	8	0.37	0.50		55	53	51	48	42	39	35	25
4 ESP 3-13	4 ESP 3-13	13	0.55	0.75		79	77	74	69	61	57	51	36
4 ESP 3-18	4 ESP 3-18	18	0.75	1.00		110	107	102	95	85	78	70	49
4 ESP 3-23	4 ESP 3-23	23	1.10	1.50		141	137	130	122	109	100	90	63
4 ESP 3-28	4 ESP 3-28	28	1.50	2.00		171	166	159	148	132	122	109	77
4 ESP 3-33	4 ESP 3-33	33	1.50	2.00		202	196	187	175	156	144	129	90
4 ESP 3-40	4 ESP 3-40	40	2.20	3.00		244	238	227	212	189	174	156	110
4 ESP 3-48	4 ESP 3-48	48	2.20	3.00		293	285	272	254	227	209	188	132
	4 ESP 3-55	55	3.00	4.00		336	327	312	291	260	240	215	151

جدول ابعاد و وزن پمپ سری 3 ESP 4

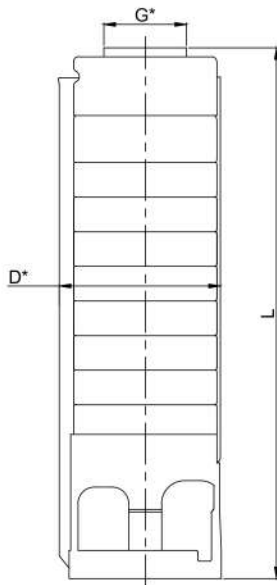

Model Name	Specification			
	D (mm)	L (mm)	Pump Weight Kg.	Weight (incl. pkg.) Kg.
4 ESP 3 - 06	98.5	280	3.2	3.8
4 ESP 3 - 09	98.5	343	4.2	5.1
4 ESP 3 - 13	98.5	427	5.4	6.7
4 ESP 3 - 18	98.5	532	7.2	9.0
4 ESP 3 - 23	98.5	668	8.9	11.2
4 ESP 3 - 28	98.5	773	10.6	13.4
4 ESP 3 - 33	98.5	878	12.2	15.5
4 ESP 3 - 40	98.5	1097	13.0	17.0
4 ESP 3 - 48	98.5	1296	14.6	19.4
4 ESP 3 - 55	99.5	1443	16.2	21.7

*G: Available Outlet Size 1.25" BSP

*D: With Cable Guard

4VP 3-75 and 4VP 4-90 pump available in 4" Joining mounted sleeve.

جدول مشخصات پمپ سری 4ESP 4

No.	PART NAME	MATERIAL
1	N.R.V. 1.25"	S.S.304
2	VALVE	S.S.304
3	VALVE SEAT	N.B.R.
4	TOP BEARING HOUSING	S.S.304
5	TOP BEARING HOUSING BUSH	N.B.R.
6	TOP BEARING HOUSING SLEEVE	S.S.304
7	THRUST WASHER	S.S.304
8	TOP DIFFUSER	S.S.304
9	DIFFUSER	S.S.304
10	BEARING BUSH	N.B.R.
11	NECKRING	N.B.R. + P.P.S.
12	IMPELLER	S.S.304
13	STAGE SLEEVE	S.S.304
14	MIDDLE BEARING HOUSING	S.S.304
15	MIDDLE BEARING HOUSING BUSH	N.B.R. + S.S.304
16	MIDDLE BEARING HOUSING SLEEVE	S.S.304
17	PUMP SHAFT	S.S.431
18	FIRST STAGE DIFFUSER	S.S.304
19	PRIMING SCREW	S.S.304
20	STRAINER	S.S.304
21	NEMA COUPLING	S.S.304
22	SUCTION INTERCONNECTOR	S.S.304
23	CLAMPING STRIP	S.S.304
24	HEX NUT	S.S.316
25	CABLE GUARD	S.S.304

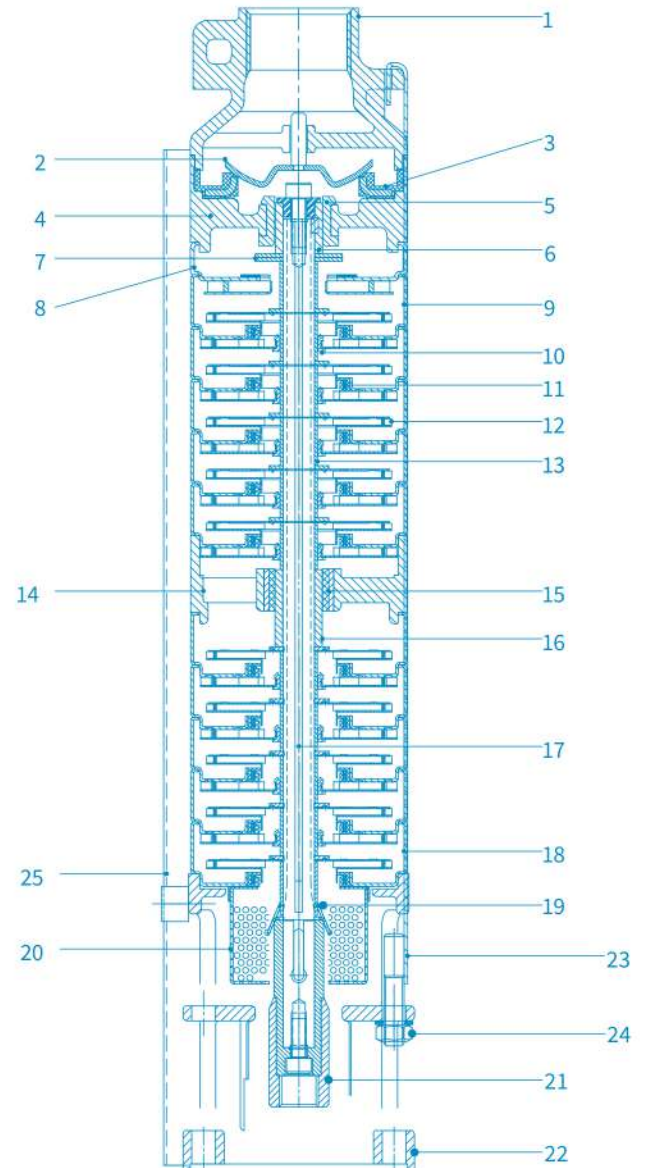

منحنی عملکرد پمپ سری 4ESP 4

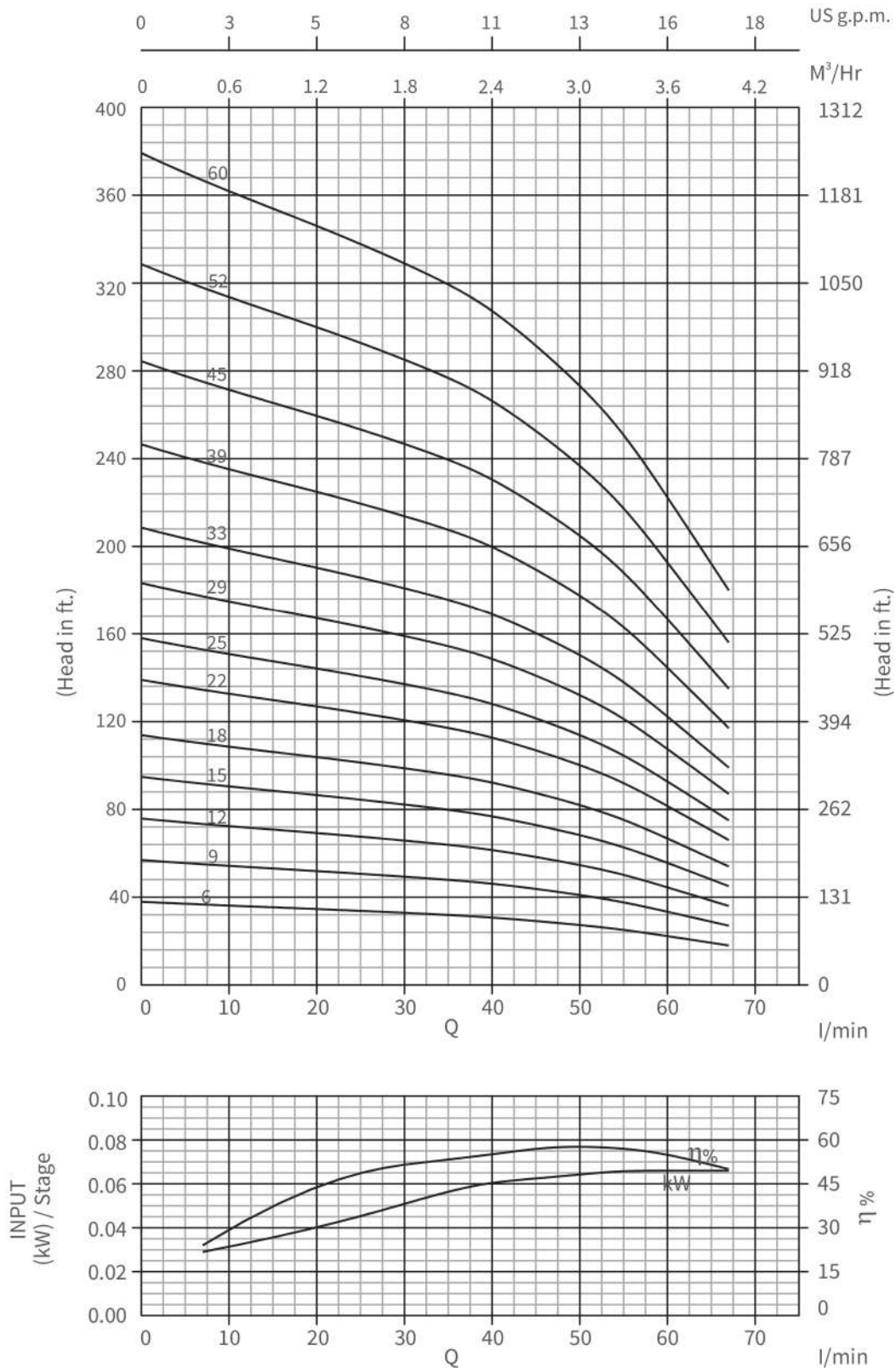

جدول عملکرد پمپ سری 4 ESP 4

Model Name		Rating			Discharge									
Single Phase	Three Phase	Stage	kW	HP	l/min	0	7	20	34	40	47	54	60	67
					m ³ /h	0	0.42	1.20	2.04	2.40	2.82	3.24	3.60	4.02

4 ESP4-06	4 ESP4-06	06	0.37	0.50	HEAD IN MTRS.	38	37	35	32	31	28	26	22	18
4 ESP4-09	4 ESP4-09	09	0.55	0.75		57	55	52	48	46	43	39	33	17
4 ESP4-12	4 ESP4-12	12	0.75	1.00		76	73	69	64	62	57	52	45	36
4 ESP4-15	4 ESP4-15	15	1.10	1.50		95	92	87	81	77	71	64	56	45
4 ESP4-18	4 ESP4-18	18	1.10	1.50		114	110	104	97	93	86	77	67	54
4 ESP4-22	4 ESP4-22	22	1.50	2.00		139	134	127	118	113	104	95	82	66
4 ESP4-25	4 ESP4-25	25	1.50	2.00		158	152	144	134	128	119	108	93	75
4 ESP4-29	4 ESP4-29	29	2.20	3.00		183	177	168	156	149	138	125	108	87
4 ESP4-33	4 ESP4-33	33	2.20	3.00		209	201	191	177	170	157	142	122	99
	4 ESP4-39	39	3.00	4.00		246	238	225	209	200	185	168	145	117
	4 ESP4-45	45	3.00	4.00		284	274	260	242	231	214	194	167	135
	4 ESP4-52	52	4.00	5.50		329	317	301	279	267	247	224	193	156
	4 ESP4-60	60	4.00	5.50		379	366	347	322	308	285	258	223	180

جدول وزن و ابعاد پمپ سری 4 ESP 4

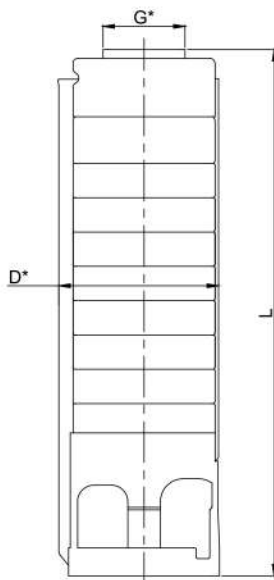

Model Name	Specification			
	D (mm)	L (mm)	Pump Weight Kg.	Weight (incl. pkg.) Kg.
4 ESP 4 - 06	98.5	280	3.4	4.0
4 ESP 4 - 09	98.5	343	4.4	5.3
4 ESP 4 - 12	98.5	406	5.4	6.6
4 ESP 4 - 15	98.5	469	6.4	7.9
4 ESP 4 - 18	98.5	532	7.4	9.2
4 ESP 4 - 22	98.5	647	8.7	10.9
4 ESP 4 - 25	98.5	710	9.7	12.2
4 ESP 4 - 29	98.5	794	10.9	13.8
4 ESP 4 - 33	98.5	878	12.2	15.5
4 ESP 4 - 39	98.5	1076	12.7	16.6
4 ESP 4 - 45	98.5	1233	14.0	18.5
4 ESP 4 - 52	98.5	1380	15.5	20.7
4 ESP 4 - 60	98.5	1548	17.3	23.3

*G: Available Outlet Size 1.25" BSP

*D: With Cable Guard

جدول مشخصات پمپ سری 6 ESP 4

No.	PART NAME	MATERIAL
1	N.R.V. 1.5"	S.S.304
2	VALVE	S.S.304
3	VALVE SEAT	N.B.R.
4	TOP BEARING HOUSING	S.S.304
5	TOP BEARING HOUSING BUSH	N.B.R.
6	TOP BEARING HOUSING SLEEVE	S.S.304
7	THRUST WASHER	S.S.304
8	TOP DIFFUSER	S.S.304
9	DIFFUSER	S.S.304
10	BEARING BUSH	N.B.R.
11	NECKRING	N.B.R. + P.P.S.
12	IMPELLER	S.S.304
13	STAGE SLEEVE	S.S.304
14	MIDDLE BEARING HOUSING	S.S.304
15	MIDDLE BEARING HOUSING BUSH	N.B.R. + S.S.304
16	MIDDLE BEARING HOUSING SLEEVE	S.S.304
17	PUMP SHAFT	S.S.431
18	FIRST STAGE DIFFUSER	S.S.304
19	PRIMING SCREW	S.S.304
20	STRAINER	S.S.304
21	NEMA COUPLING	S.S.304
22	SUCTION INTERCONNECTOR	S.S.304
23	CLAMPING STRIP	S.S.304
24	HEX NUT	S.S.316
25	CABLE GUARD	S.S.304

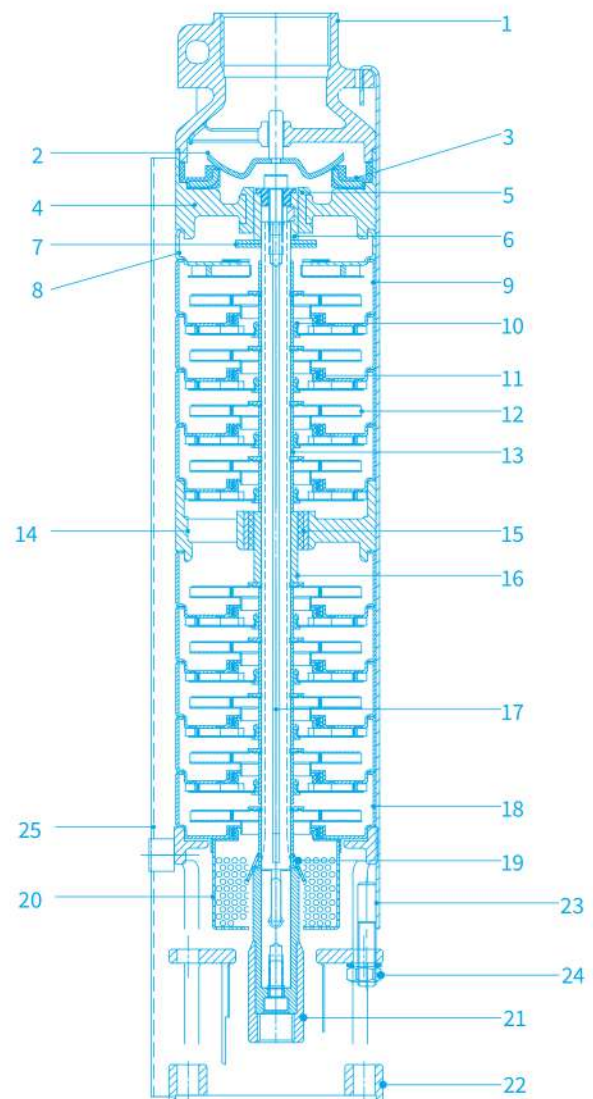

منحنی عملکرد پمپ سری 4ESP 6

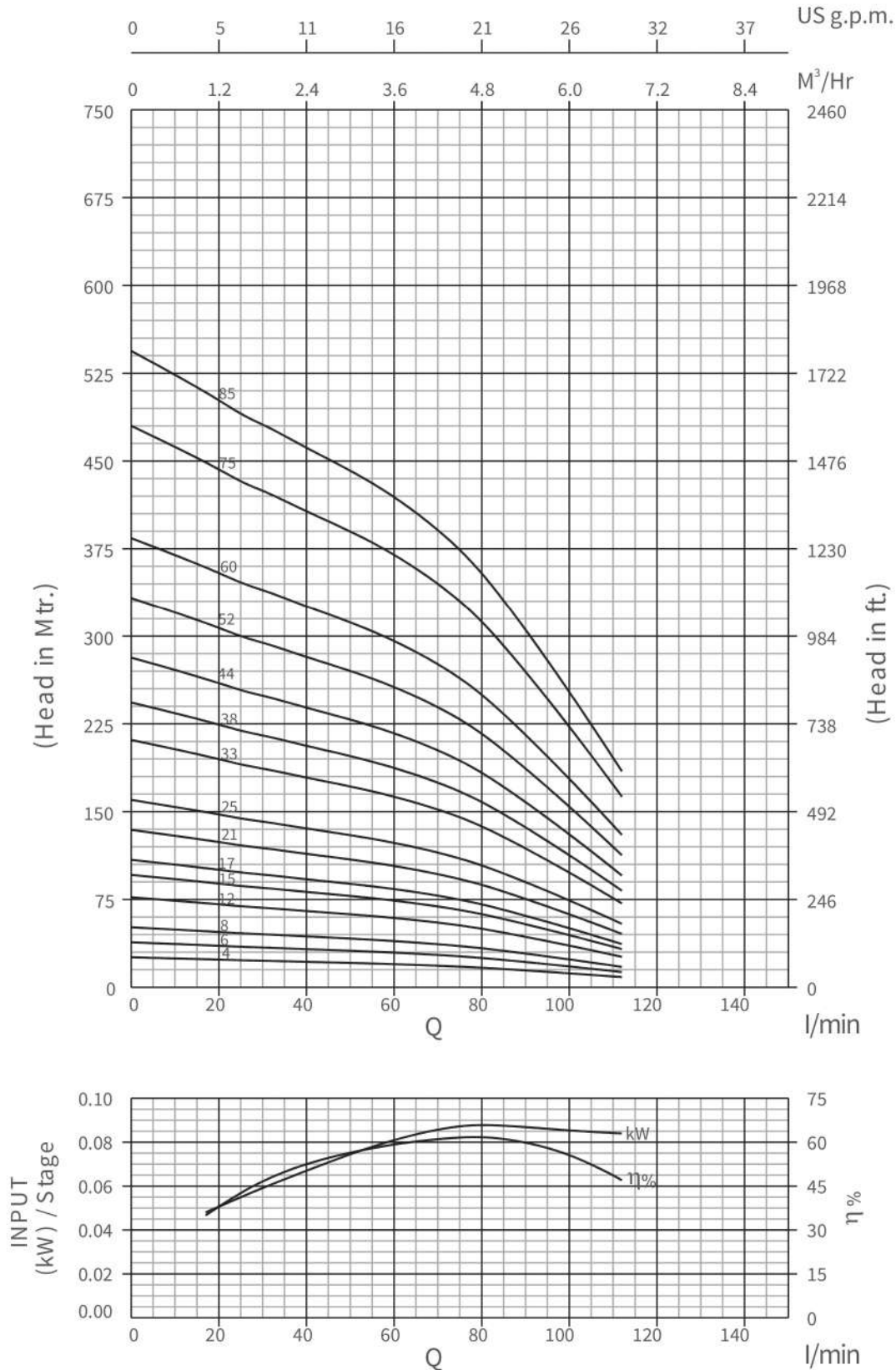

جدول عملکرد پمپ سری 4ESP 6

Single Phase	Three Phase	Stage	kW	HP	HEAD IN METRS.													
					l/min m ³ /h	0	17	25	31	40	57	74	84	101	112			
					0	1.02	1.50	1.86	2.40	3.42	4.44	5.04	6.06	6.72				

4 ESP6-04	4 ESP6-04	4	0.37	0.50	26	24	23	22.5	22	20	18	16	12	9
4 ESP6-06	4 ESP6-06	6	0.55	0.75	38	36	34.5	34	33	30	27	24	18	13
4 ESP6-08	4 ESP6-08	8	0.75	1.00	51	48	46	45	43	40	36	32	23	17
4 ESP6-12	4 ESP6-12	12	1.10	1.50	77	72	69	68	65	61	54	48	35	26
4 ESP6-15	4 ESP6-15	15	1.50	2.00	96	90	86	85	81	76	67	60	44	33
4 ESP6-17	4 ESP6-17	17	1.50	2.00	109	102	98	96	92	86	76	67	50	37
4 ESP6-21	4 ESP6-21	21	2.20	3.00	134	126	121	119	114	106	94	83	61	46
4 ESP6-25	4 ESP6-25	25	2.20	3.00	160	150	144	141	136	126	112	99	73	54
	4 ESP6-33	33	3.00	4.00	211	198	190	186	179	167	148	131	96	72
	4 ESP6-38	38	4.00	5.50	243	228	218	215	206	192	170	151	111	82
	4 ESP6-44	44	4.00	5.50	282	264	253	249	238	222	197	175	128	95
	4 ESP6-52	52	5.50	7.50	333	312	299	294	282	263	233	206	152	113
	4 ESP6-60	60	5.50	7.50	384	360	345	339	325	303	269	238	175	130
	4 ESP6-75	75	7.50	10.00	480	450	431	424	406	379	336	298	219	163
	4 ESP6-85	85	7.50	10.00	544	510	489	480	461	429	381	337	248	184

جدول وزن و ابعاد پمپ سری 4ESP 6

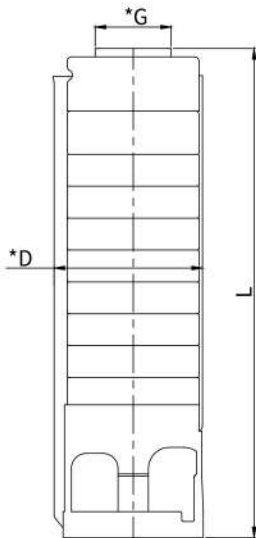

Model Name	Specification			
	*D (mm)	L (mm)	Pump Weight Kg.	Weight (incl. pkg.) Kg.
4ESP 6 - 04	98	238	3.2	3.4
4ESP 6 - 06	98	280	3.6	3.9
4ESP 6 - 08	98	322	4.0	4.4
4ESP 6 - 12	98	406	5.6	6.2
4ESP 6 - 15	98	469	6.6	7.4
4ESP 6 - 17	98	511	7.0	7.9
4ESP 6 - 21	98	626	8.4	9.5
4ESP 6 - 25	98	710	9.7	11.0
4ESP 6 - 33	98	878	12.5	14.2
4ESP 6 - 38	98	1169	13.0	14.7
4ESP 6 - 44	98	1344	14.0	16.0
4ESP 6 - 52	98	1536	16.3	18.6
4ESP 6 - 60	98	1728	18.6	21.3
4ESP 6 - 52	119	1628	25.0	27.3
4ESP 6 - 60	119	1820	27.0	29.4
4ESP 6 - 75	138	2423	43.5	46.1
4ESP 6 - 85	138	2694	47.5	50.5

*G: Available Outlet Size 1.5" BSP

*D: With Cable Guard

4VP 6 - 52 and 4VP6 - 60 pump available in 6" Joining

4VP 6 - 75 and 4VP 6 - 85 pump available in 6" Joining with mounted sleeve.

جدول مشخصات پمپ سری 9 ESP 4

No	PART NAME	MATERIAL
1	N.R.V. 2.0"	S.S.304
2	VALVE	S.S.304
3	TOP BEARING BUSH	N.B.R.
4	TOP DIFFUSER	S.S.304
5	COLLET & COLLET NUT	S.S.304
6	IMPELLER	S.S.304
7	NECKRING	N.B.R. + NYLON
8	DIFFUSER	S.S.304
9	BEARING BUSH	N.B.R.
9	STAGE SLEEVE	S.S.304
10	PUMP SHAFT	S.S.431
11	CLAMPING STRIP	S.S.304
12	STRAINER	S.S.304
13	NEMA COUPLING	S.S.304
14	CABLE GUARD	S.S.304
15	SUCTION	S.S.304

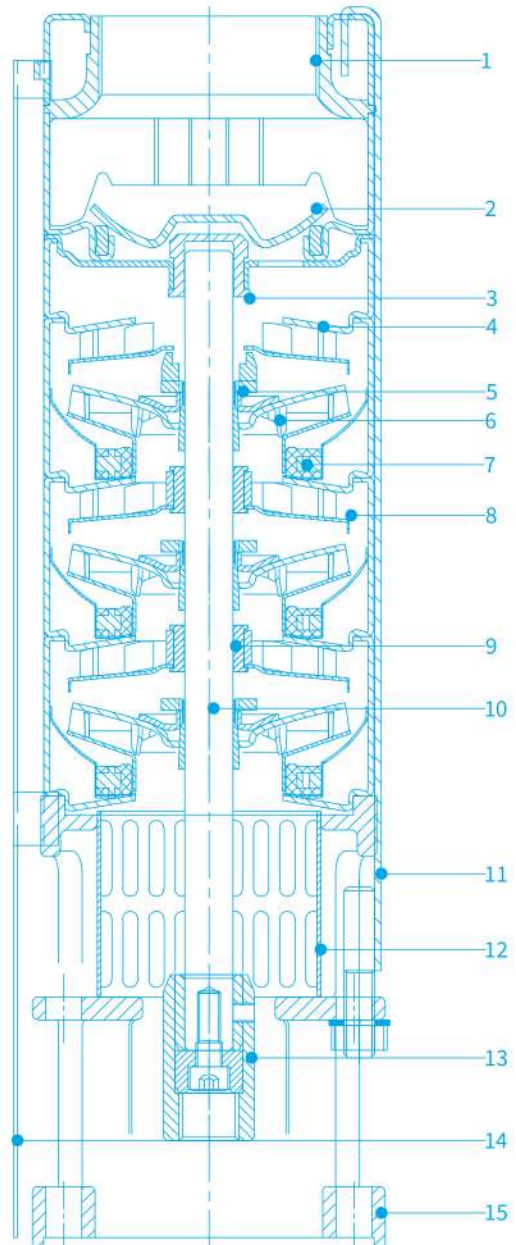

منحنی عملکرد پمپ سری 4ESP 9

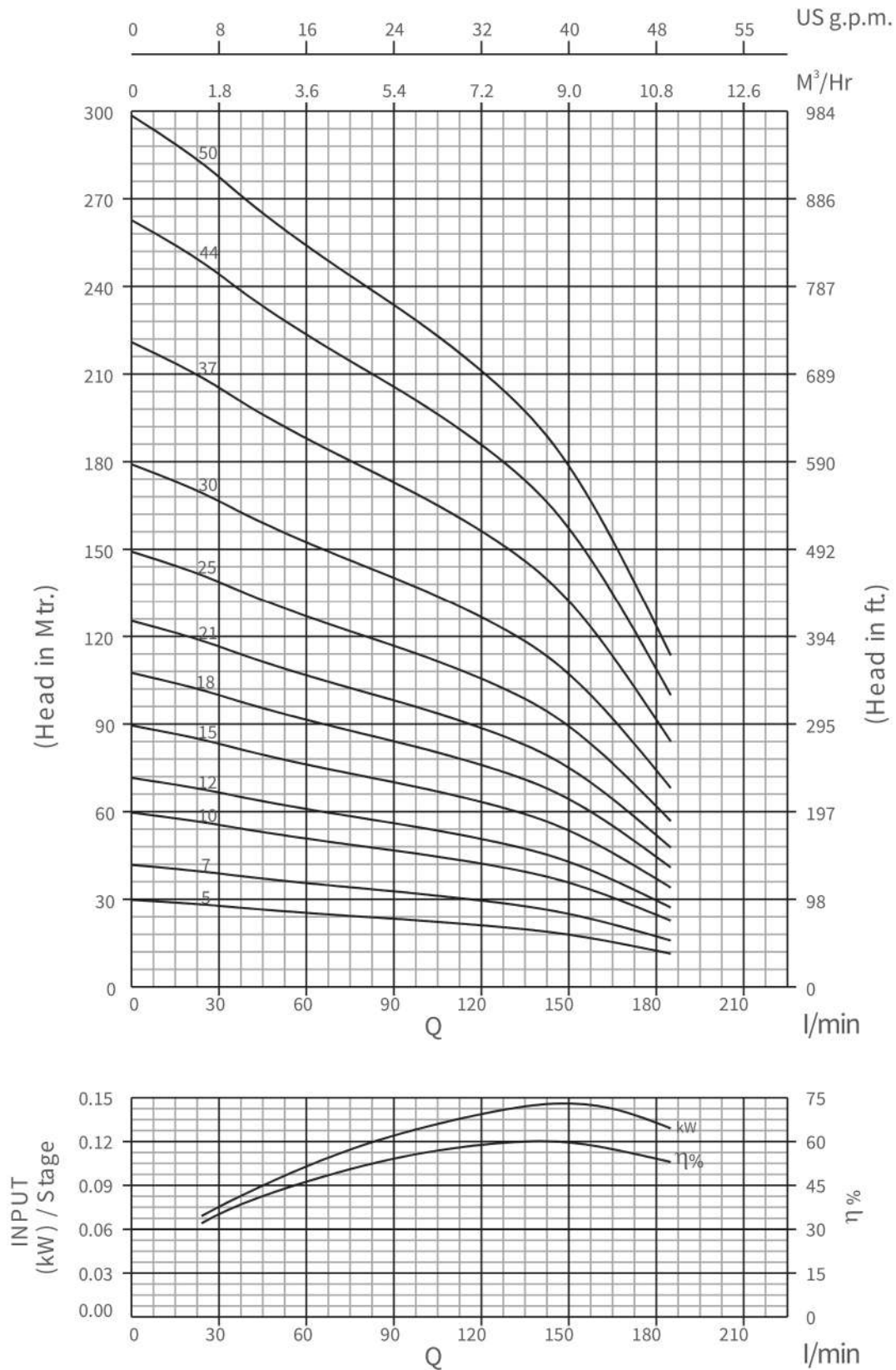

جدول عملکرد پمپ سری 4ESP 9

Model Name		Stage	Rating		Discharge									
Single Phase	Three Phase		kW	HP	l/min m ³ /h	0	24	34	67	101	134	151	168	185

4ESP9-05	4ESP9-05	5	0.75	1.00	HEAD IN Mtrs.	30	28	27	25	23	20	18	15	11	
4ESP9-07	4ESP9-07	7	1.10	1.50		42	40	38	35	32	28	25	21	16	
4ESP9-10	4ESP9-10	10	1.50	2.00		60	57	55	50	45	40	36	30	23	
4ESP9-12	4ESP9-12	12	2.20	3.00		72	68	66	60	54	48	43	36	27	
4ESP9-15	4ESP9-15	15	2.20	3.00		90	85	82	75	68	60	54	45	34	
	4ESP9-18	18	3.00	4.00		107	102	98	89	82	72	64	53	41	
	4ESP9-21	21	4.00	5.50		125	119	115	104	95	84	75	62	48	
	4ESP9-25	25	4.00	5.50		149	142	136	124	114	100	89	74	57	
	4ESP9-30	30	5.50	7.50		179	170	164	149	136	120	107	89	68	
	4ESP9-37	37	5.50	7.50		221	210	202	184	168	148	132	110	84	
	4ESP9-44	44	7.50	10.00		263	249	240	219	200	176	157	131	100	
	4ESP9-50	50	7.50	10.00		298	284	273	248	227	200	178	148	114	

جدول وزن و ابعاد پمپ سری 4ESP 9

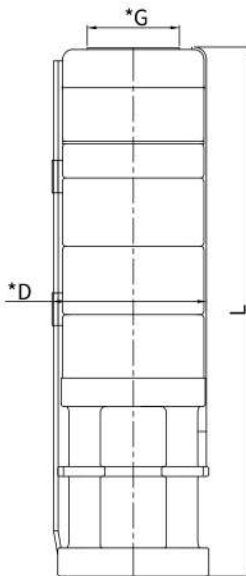

Model Name	Specification			
	*D (mm)	L (mm)	Pump Weight Kg.	Weight (incl. pkg.) Kg.
4ESP9 - 05	98	410	7.2	10.2
4ESP9 - 07	98	494	7.7	10.7
4ESP9 - 10	98	620	8.4	11.4
4ESP9 - 12	98	704	8.9	11.9
4ESP9 - 15	98	830	9.7	12.7
4ESP9 - 18	98	956	10.5	13.5
4ESP9 - 21	98	1082	11.2	14.2
4ESP9 - 25	98	1250	12.3	15.3
4ESP9 - 30	98	1460	13.5	16.5
4ESP9 - 37	98	1754	15.3	18.3
4ESP9 - 44	98	2048	17.1	20.1
4ESP9 - 50	98	2300	18.8	21.8

*G: Available Outlet Size BSP 2.0"

* D: With Cable Guard

4VP 9 -30, 4VP 9 -37, VP8A-44 & 4VP 9 -50

pump are also available in 6" Joining.

4VP 9 -58, 4VP 9 -66, 4VP 9 -73, 4VP 9 -82,

4VP 9 -91, 4VP 9 -100 & 4VP 9 -110 pump are

also available in 6" Joining with mounted sleeve.

جدول مشخصات پمپ سری 14 ESP 4

No.	PART NAME	MATERIAL
1	SUCTION	CF8
2	STRAINER	S.S.304
3	SS CONNECTOR	S.S.304
4	COUPLING	S.S.304
5	PUMP SHAFT	SS 1.4362
6	IMPELLER	S.S.304
7	COLLET	S.S.304
8	NUT OF COLLET	S.S.304
9	DIFFUSER	S.S.304
10	BEARING BUSH	N.B.R.
11	NECKRING	NBR+NYLON
12	SPACING WASER	PIFE
13	VALVE ASSLY	S.S.304
14	N.R.V.	CF8
15	CLAMPING STRIP	S.S.304
16	WASHER 8X15.5X1.5	S.S.304
17	HHNUTM8X1.25P	S.S.316
18	CABLE&CLAMP	S.S.304

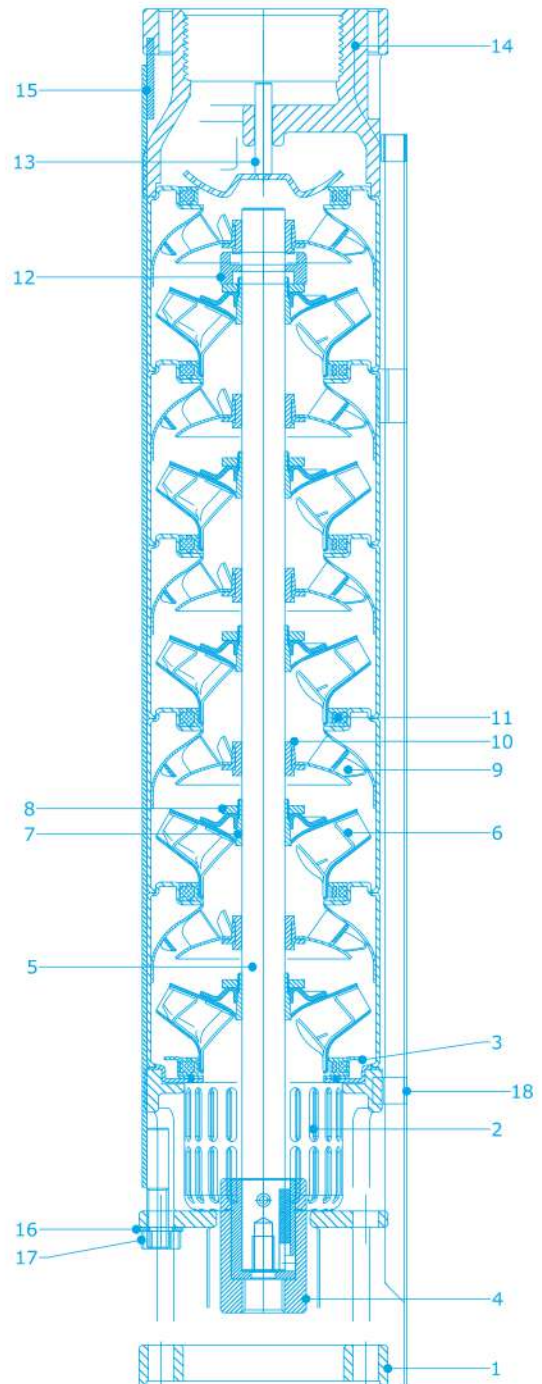

منحنی عملکرد پمپ سری 4ESP 14

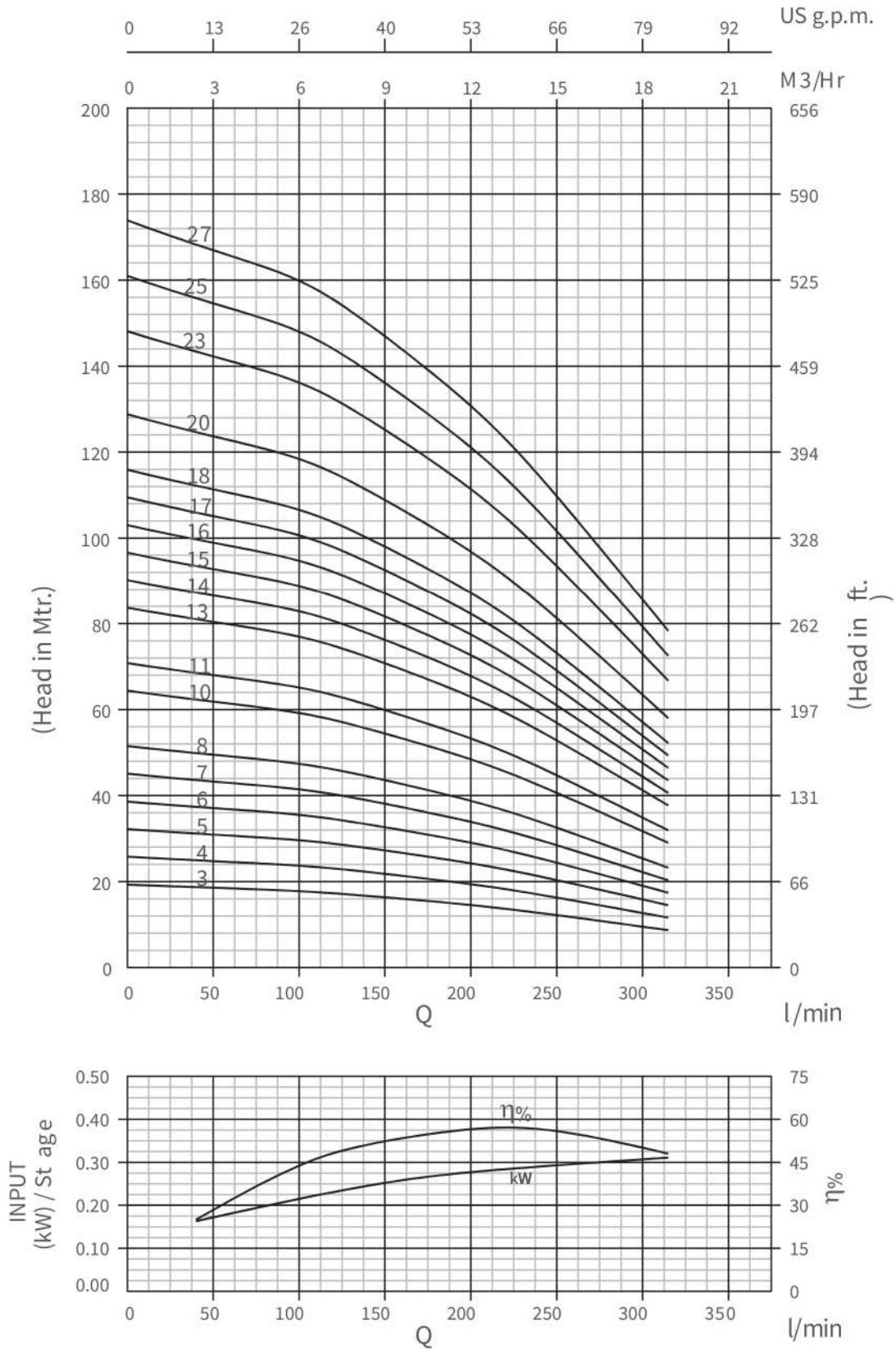

جدول عملکرد پمپ سری 4ESP 14

Model Name		Stage	Rating		Discharge							
Single Phase	Three Phase		kW	HP	l/min	0	40	95	130	170	215	260

Model Name	Three Phase	Stage	kW	HP	HEAD IN Mtrs.	0	40	95	130	170	215	260	315
4 ESP14-03	4 ESP 14-03	03	1.10	1.50	19	18.5	18	17	16	14	12	9	
4 ESP14-04	4 ESP 14-04	04	1.10	1.50	26	25	24	23	21	19	16	12	
4 ESP14-05	4 ESP 14-05	05	1.50	2.00	32	31	30	28	26	23	20	14	
4 ESP14-06	4 ESP 14-06	06	1.50	2.00	39	37	36	34	31	28	23	17	
4 ESP14-07	4 ESP 14-07	07	2.20	3.00	45	44	42	40	37	33	27	20	
4 ESP14-08	4 ESP 14-08	08	2.20	3.00	52	50	48	45	42	37	31	23	
	4 ESP 14-10	10	3.00	4.00	64	62	60	57	52	47	39	29	
	4 ESP 14-11	11	3.00	4.00	71	68	66	62	57	51	43	32	
	4 ESP 14-13	13	3.00	4.00	84	81	78	74	68	61	51	38	
	4 ESP 14-14	14	4.00	5.50	90	87	84	79	73	65	55	41	
	4 ESP 14-15	15	4.00	5.50	97	93	90	85	78	70	58	44	
	4 ESP 14-16	16	4.00	5.50	103	100	96	91	84	75	62	46	
	4 ESP 14-17	17	4.00	5.50	109	106	102	96	89	79	66	49	
	4 ESP 14-18	18	5.50	7.50	116	112	108	102	94	84	70	52	
	4 ESP 14-20	20	5.50	7.50	129	124	120	113	104	93	78	58	
	4 ESP 14-23	23	5.50	7.50	148	143	138	130	120	107	90	67	
	4 ESP 14-25	25	7.50	10.00	161	156	150	142	130	117	98	72	
	4 ESP 14-27	27	7.50	10.00	174	168	162	153	141	126	105	78	

منحنی وزن و ابعاد پمپ سری 4ESP 14

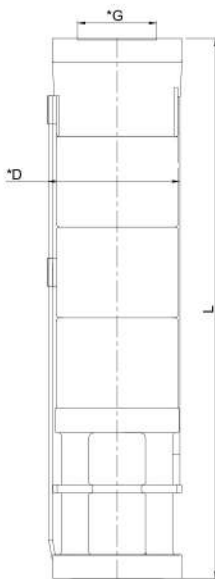

Model Name	Specification			
	*D (mm)	L (mm)	Pump Weight Kg.	Weight (incl.pkg.) Kg.
4 ESP 14 - 03	98	387	4.70	5.4
4 ESP 14 - 04	98	452	5.40	6.2
4 ESP 14 - 05	98	517	6.10	7.0
4 ESP 14 - 06	98	582	6.9	7.9
4 ESP 14 - 07	98	647	7.7	8.9
4 ESP 14 - 08	98	712	8.4	9.7
4 ESP 14 - 10	98	842	9.9	11.4
4 ESP 14 - 11	98	907	10.6	12.2
4 ESP 14 - 13	98	1037	12.1	13.9
4 ESP 14 - 14	98	1102	12.9	14.8
4 ESP 14 - 15	98	1167	13.6	15.6
4 ESP 14 - 16	98	1232	14.4	16.6
4 ESP 14 - 17	98	1297	15.1	17.4
4 ESP 14 - 18	98	1362	16.6	19.1
4 ESP 14 - 20	98	1492	18.1	20.8
4 ESP 14 - 23	98	1687	20.4	23.5
4 ESP 14 - 25	98	1817	21.9	25.2
4 ESP 14 - 27	98	1947	23.4	26.9

* G:\Available Outlet Size BSP 2.0"

* D:\ With Cable Guard

4VP 14 -18, 4VP 14 -25 & 4VP 14 -27 pump are also available in 6" Joining

جدول مشخصات پمپ سری 15 ESP 6

NO	PART NAME	MATERIAL
1	N.R.V.	S.S.304
2	VALVE	S.S.304
3	VALVE SEAT	N.B.R. + S.S.304
4	TOP CAP	S.S.304
5	SPACING WASHER	TEFLON
6	INTERMEDIATE CHAMBER TOP	S.S.304
7	BEARING BUSH	N.B.R.
8	NECKRING	N.B.R. + NYLON
9	INTERMEDIATE CHAMBER	S.S.304
10	COLLET & COLLET NUT	S.S.304
11	IMPELLER	S.S.304
12	PUMP SHAFT	S.S.431
13	CLAMPING STRIP	S.S.304
14	SUCTION CONNECTOR	S.S.304
15	STRAINER	S.S.304
16	PRIMING SCREW	S.S.304
17	NEMA COUPLING	S.S.304
18	CABLE GUARD	S.S.304
19	SUCTION	S.S.304
20	HEX NUT	S.S.316

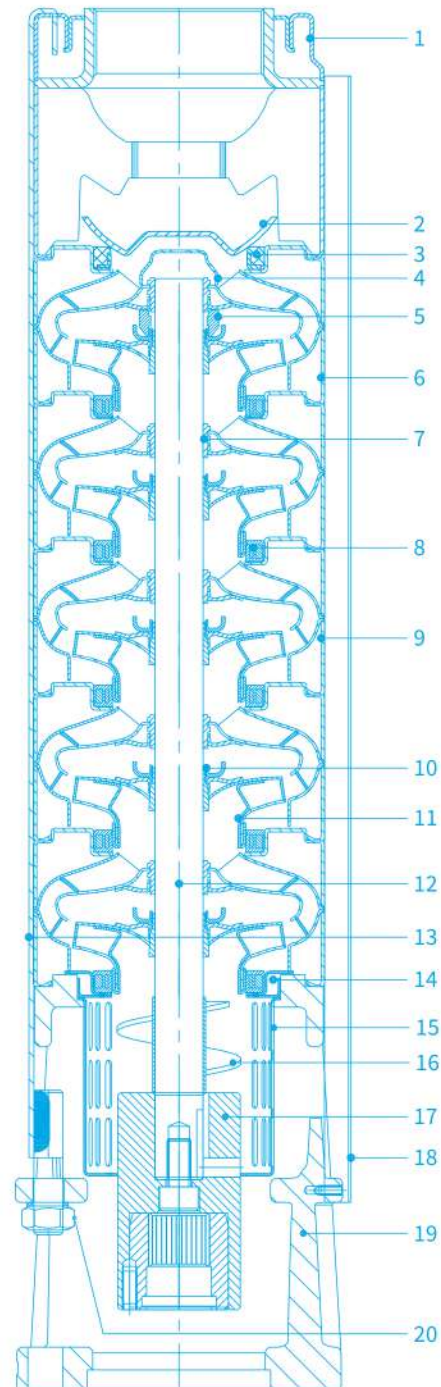

منحنی عملکرد پمپ سری 6ESP 15

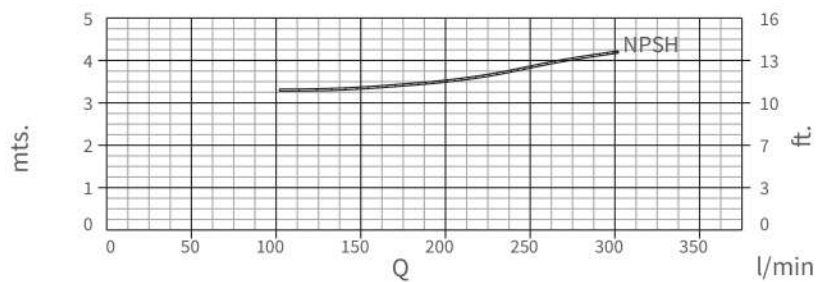
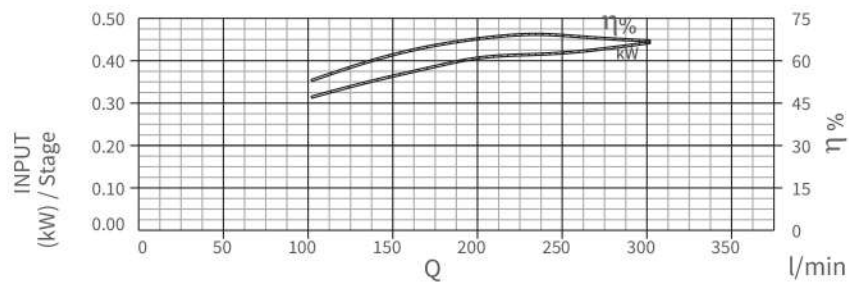
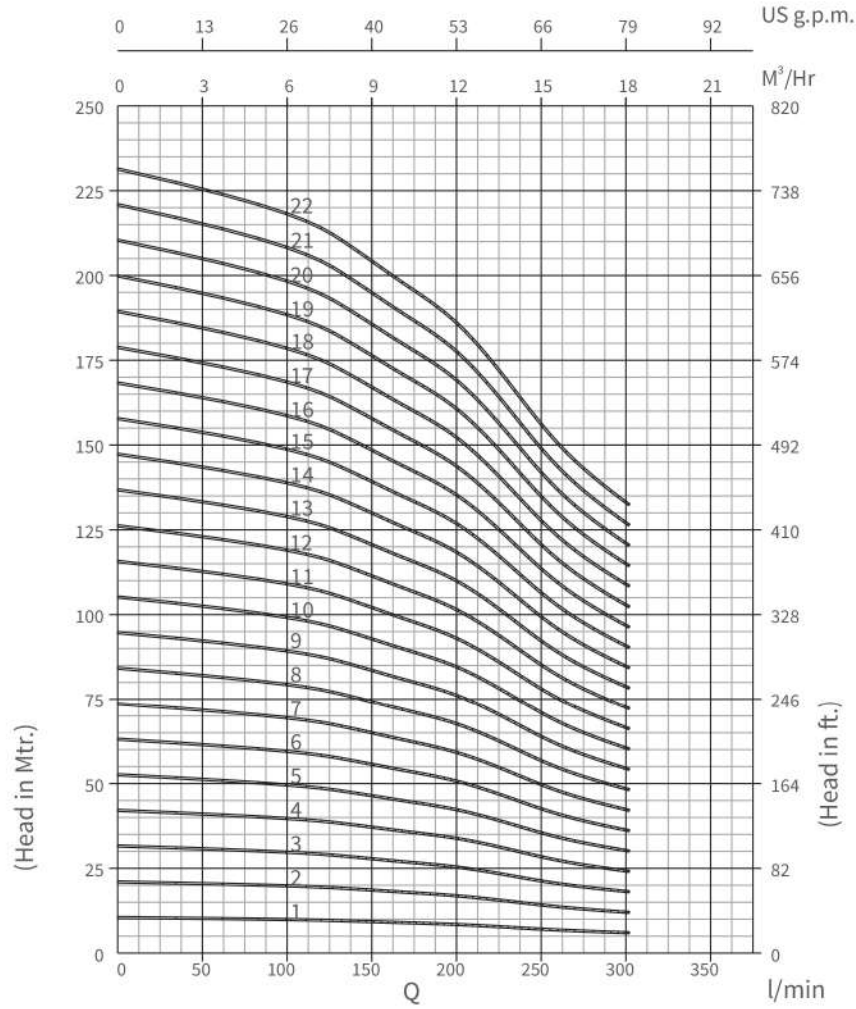

منحنی عملکرد پمپ سری 6ESP 15

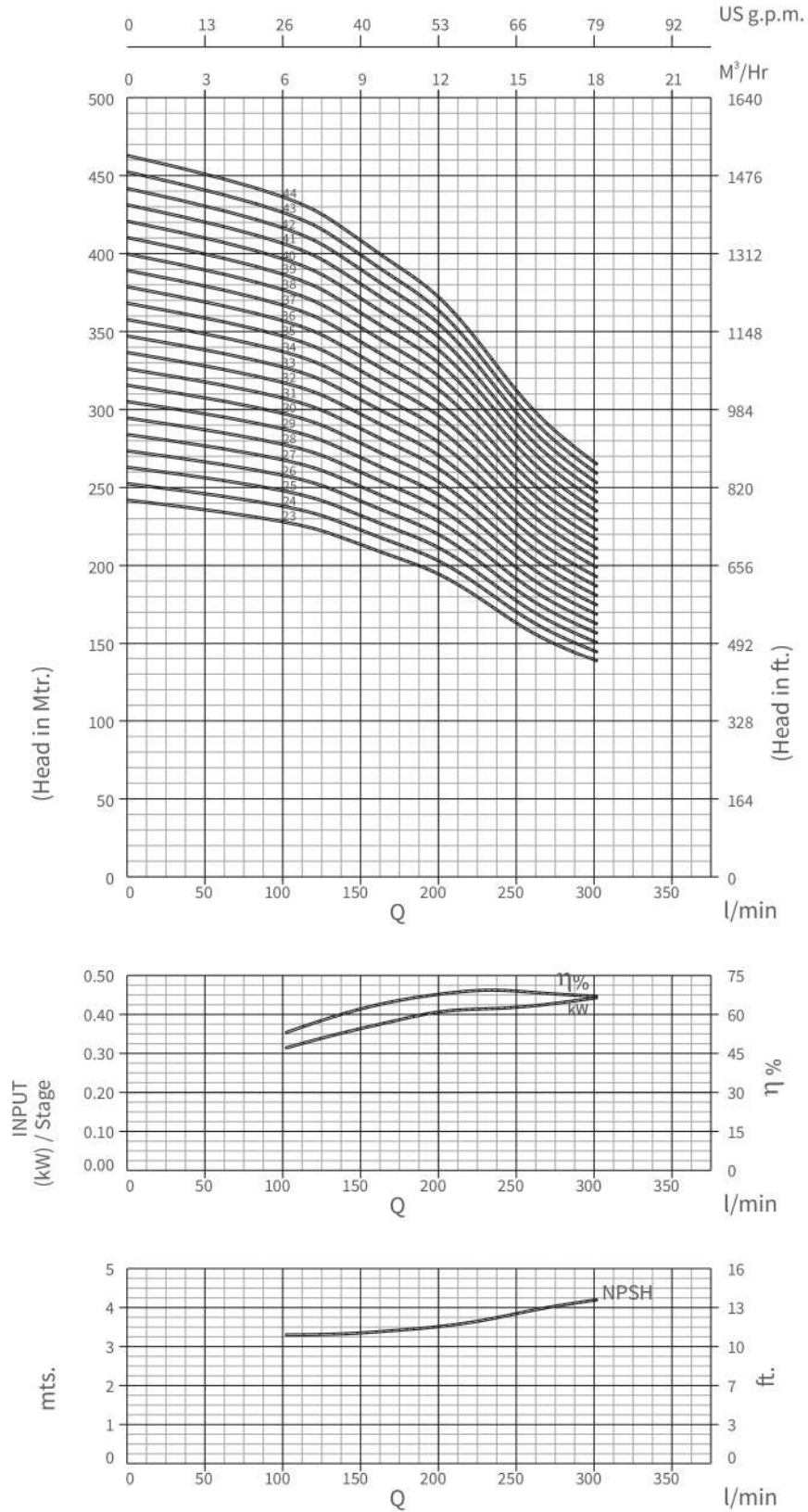

جدول عملکرد پمپ سری 6ESP 15

MODEL NAME	STAGE	RATING		l/min m ³ /h	DISCHARGE							
		kW	HP		0	102	135	168	201	235	266	302

MODEL NAME	STAGE	kW	HP	10.5	10	9.5	9	8.5	7.5	7	6
6 ESP 15-01	1	0.55	0.75	10.5	10	9.5	9	8.5	7.5	7	6
6 ESP 15-02	2	1.10	1.50	21	20	19	18	17	15	13	12
6 ESP 15-03	3	1.50	2.00	32	30	29	27	26	23	20	18
6 ESP 15-04	4	2.20	3.00	42	40	38	36	34	30	26	24
6 ESP 15-05	5	2.20	3.00	53	50	48	45	43	38	33	30
6 ESP 15-06	6	3.00	4.00	63	60	57	54	51	45	40	36
6 ESP 15-07	7	3.00	4.00	74	70	67	63	60	53	46	42
6 ESP 15-08	8	4.00	5.50	84	80	76	72	68	60	53	48
6 ESP 15-09	9	4.00	5.50	95	90	86	81	77	68	59	54
6 ESP 15-10	10	5.50	7.50	105	100	95	90	85	75	66	60
6 ESP 15-11	11	5.50	7.50	116	110	105	99	94	83	73	66
6 ESP 15-12	12	5.50	7.50	126	120	114	108	102	90	79	72
6 ESP 15-13	13	7.50	10.00	137	130	124	117	111	98	86	78
6 ESP 15-14	14	7.50	10.00	147	140	134	126	119	106	92	84
6 ESP 15-15	15	7.50	10.00	158	150	143	135	128	113	99	90
6 ESP 15-16	16	7.50	10.00	168	160	153	144	136	121	106	96
6 ESP 15-17	17	9.30	12.50	179	170	162	153	145	128	112	102
6 ESP 15-18	18	9.30	12.50	189	180	172	162	153	136	119	108
6 ESP 15-19	19	9.30	12.50	200	190	181	171	162	143	125	114
6 ESP 15-20	20	9.30	12.50	210	200	191	180	170	151	132	120
6 ESP 15-21	21	11.00	15.00	221	210	200	189	179	158	139	126
6 ESP 15-22	22	11.00	15.00	231	220	210	198	187	166	145	132
6 ESP 15-23	23	11.00	15.00	242	230	219	207	196	173	152	138
6 ESP 15-24	24	11.00	15.00	252	240	229	216	204	181	158	144
6 ESP 15-25	25	13.00	17.50	263	250	238	224	213	188	165	150
6 ESP 15-26	26	13.00	17.50	274	260	248	233	222	196	172	157
6 ESP 15-27	27	13.00	17.50	284	270	258	242	230	204	178	163
6 ESP 15-28	28	13.00	17.50	295	280	267	251	239	211	185	169
6 ESP 15-29	29	15.00	20.00	305	290	277	260	247	219	191	175
6 ESP 15-30	30	15.00	20.00	316	300	286	269	256	226	198	181
6 ESP 15-31	31	15.00	20.00	326	310	296	278	264	234	205	187
6 ESP 15-32	32	15.00	20.00	337	320	305	287	273	241	211	193
6 ESP 15-33	33	15.00	20.00	347	330	315	296	281	249	218	199
6 ESP 15-34	34	18.50	25.00	358	340	324	305	290	256	224	205
6 ESP 15-35	35	18.50	25.00	368	350	334	314	298	264	231	211
6 ESP 15-36	36	18.50	25.00	379	360	343	323	307	271	238	217
6 ESP 15-37	37	18.50	25.00	389	370	353	332	315	279	244	223
6 ESP 15-38	38	18.50	25.00	400	380	363	341	324	287	251	229
6 ESP 15-39	39	18.50	25.00	410	390	372	350	332	294	257	235
6 ESP 15-40	40	18.50	25.00	421	400	382	359	341	302	264	241
6 ESP 15-41	41	22.00	30.00	431	410	391	368	349	309	271	247
6 ESP 15-42	42	22.00	30.00	442	420	401	377	358	317	277	253
6 ESP 15-43	43	22.00	30.00	452	430	410	386	366	324	284	259
6 ESP 15-44	44	22.00	30.00	463	440	420	395	375	332	290	265

HEAD IN Mtrs.

جدول وزن و ابعاد پمپ سری 15 ESP 6

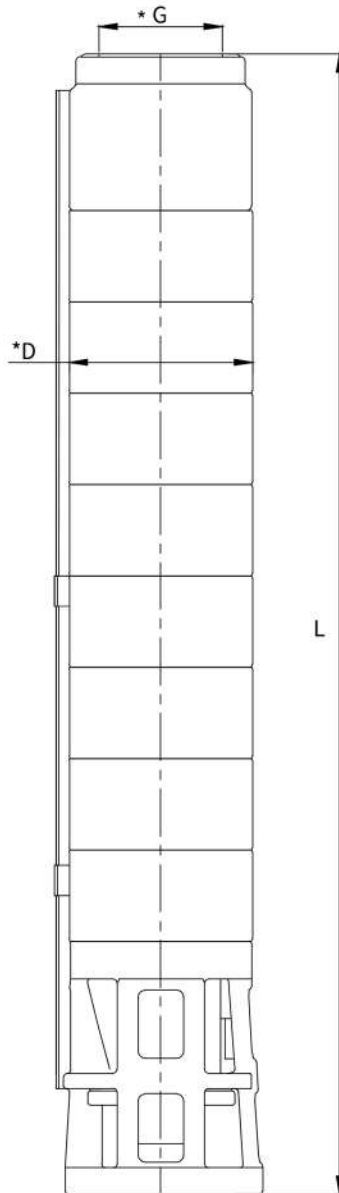

Model Name	Specification			
	*D (mm)	L (mm)	Pump Weight Kg	Weight (Incl. pkg) Kg
6 ESP 15 - 1	142	331	8	10
6 ESP 15 - 2	142	392	9	11
6 ESP 15 - 3	142	452	10	12
6 ESP 15 - 4	142	513	12	14
6 ESP 15 - 5	142	573	13	15
6 ESP 15 - 6	142	634	14	16
6 ESP 15 - 7	142	694	15	17
6 ESP 15 - 8	142	755	17	19
6 ESP 15 - 9	142	815	18	20
6 ESP 15 - 10	142	876	19	21
6 ESP 15 - 11	142	936	20	23
6 ESP 15 - 12	142	997	22	24
6 ESP 15 - 13	142	1057	23	25
6 ESP 15 - 14	142	1118	24	26
6 ESP 15 - 15	142	1178	25	28
6 ESP 15 - 16	142	1239	26	29
6 ESP 15 - 17	142	1299	28	31
6 ESP 15 - 18	142	1360	29	32
6 ESP 15 - 19	142	1420	30	33
6 ESP 15 - 20	142	1481	31	34
6 ESP 15 - 21	142	1541	33	36
6 ESP 15 - 22	142	1602	34	37
6 ESP 15 - 23	142	1662	35	39
6 ESP 15 - 24	142	1723	36	40
6 ESP 15 - 25	142	1783	38	41
6 ESP 15 - 26	142	1844	39	42
6 ESP 15 - 27	142	1904	40	43
6 ESP 15 - 28	142	1965	41	45
6 ESP 15 - 29	142	2025	42	46
6 ESP 15 - 30	142	2086	44	47
6 ESP 15 - 31	142	2146	45	49
6 ESP 15 - 32	142	2207	46	50
6 ESP 15 - 33	142	2267	47	51
6 ESP 15 - 34	142	2328	49	53
6 ESP 15 - 35	142	2388	50	54
6 ESP 15 - 36	142	2449	51	55
6 ESP 15 - 37	142	2509	52	56
6 ESP 15 - 38	142	2570	53	57
6 ESP 15 - 39	142	2630	55	59
6 ESP 15 - 40	142	2691	56	60
6 ESP 15 - 41	142	2751	57	62
6 ESP 15 - 42	142	2812	58	63
6 ESP 15 - 43	142	2872	60	64
6 ESP 15 - 44	142	2933	61	65

*G : Available Outlet Size BSP 2.5"

*D : With Cable Guard

6VP 15-01 to 6VP 15-16 Pumps Are Also Available In 4" Joining

جدول مشخصات پمپ سری 6ESP 18

No	PART NAME	MATERIAL
1	N.R.V. 2.5"	S.S.304
2	VALVE	S.S.304
3	VALVE SEAT	N.B.R. + S.S.304
4	TOP CAP	S.S.304
5	SPACING WASHER	25% CFT
6	INTERMEDIATE CHAMBER TOP	S.S.304
7	BEARING BUSH	N.B.R.
8	NECKRING	N.B.R. + NYLON
9	INTERMEDIATE CHAMBER	S.S.304
10	COLLET & COLLET NUT	S.S.304
11	IMPELLER	S.S.304
12	PUMP SHAFT	S.S.431
13	CLAMPING STRIP	S.S.304
14	SUCTION CONNECTOR	S.S.304
15	STRAINER	S.S.304
16	PRIMING SCREW	S.S.304
17	NEMA COUPLING	S.S.304
18	CABLE GUARD	S.S.304
19	SUCTION	S.S.304
20	HEX NUT	S.S.316

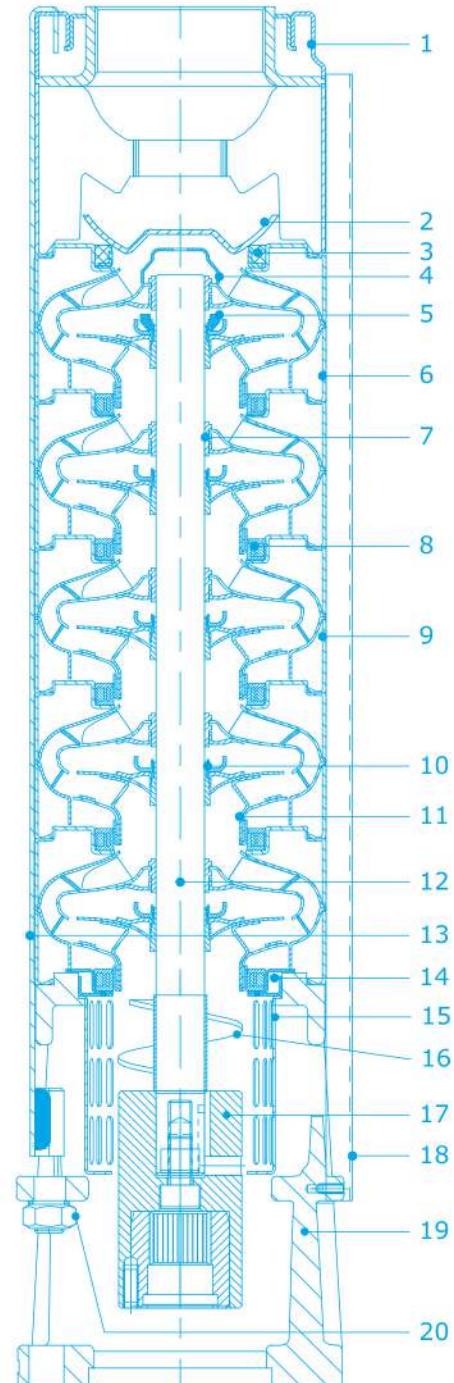

منحنی عملکرد پمپ سری 6ESP 18,50Hz

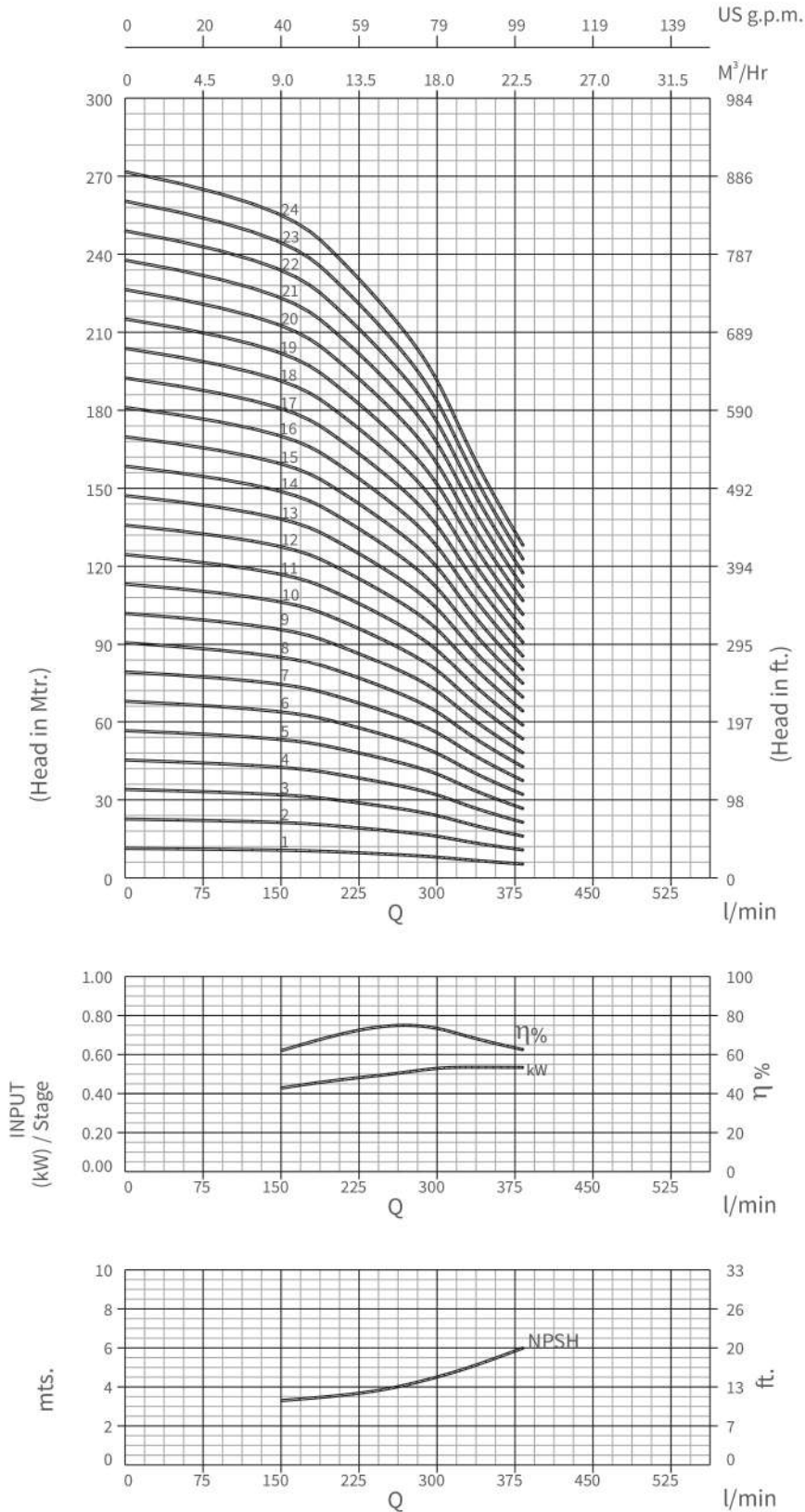

جدول عملکرد پمپ سری 6ESP 18,50Hz

MODEL NAME	STAGE	RATING		l/min m ³ /h	Discharge						
		kW	HP		0	150	200	250	300	333	383
THREE PHASE					0	9	12	15	18	20	23

MODEL NAME	STAGE	kW	HP	HEAD IN Mtrs.	0	150	200	250	300	333	383
6 ESP 18-01	1	0.55	0.75		11.3	11	10	9	8	7	5
6 ESP 18-02	2	1.10	1.50		23	22	20	18	16	13	11
6 ESP 18-03	3	2.20	3.00		34	32	30	27	24	20	16
6 ESP 18-04	4	2.20	3.00		45	43	40	37	33	27	21
6 ESP 18-05	5	3.00	4.00		57	54	50	46	41	34	27
6 ESP 18-06	6	4.00	5.50		68	65	60	55	49	40	32
6 ESP 18-07	7	4.00	5.50		79	76	70	64	57	47	37
6 ESP 18-08	8	5.50	7.50		91	87	80	73	65	54	43
6 ESP 18-09	9	5.50	7.50		102	97	91	82	73	60	48
6 ESP 18-10	10	5.50	7.50		113	108	101	92	81	67	53
6 ESP 18-11	11	7.50	10.00		125	119	111	101	89	74	59
6 ESP 18-12	12	7.50	10.00		136	130	121	110	98	80	64
6 ESP 18-13	13	7.50	10.00		147	141	131	119	106	87	69
6 ESP 18-14	14	9.30	12.50		158	152	141	128	114	94	75
6 ESP 18-15	15	9.30	12.50		170	162	151	137	122	100	80
6 ESP 18-16	16	9.30	12.50		181	173	161	147	130	107	85
6 ESP 18-17	17	9.30	12.50		192	184	171	156	138	114	91
6 ESP 18-18	18	11.00	15.00		204	195	181	165	146	121	96
6 ESP 18-19	19	11.00	15.00		215	206	191	174	154	127	101
6 ESP 18-20	20	11.00	15.00		226	217	201	183	163	134	107
6 ESP 18-21	21	13.00	17.50		238	227	211	192	171	141	112
6 ESP 18-22	22	13.00	17.50		249	238	221	202	179	147	117
6 ESP 18-23	23	13.00	17.50		260	249	231	211	187	154	123
6 ESP 18-24	24	13.00	17.50		272	260	241	220	195	161	128

منحنی عملکرد پمپ سری 6ESP 18,50Hz

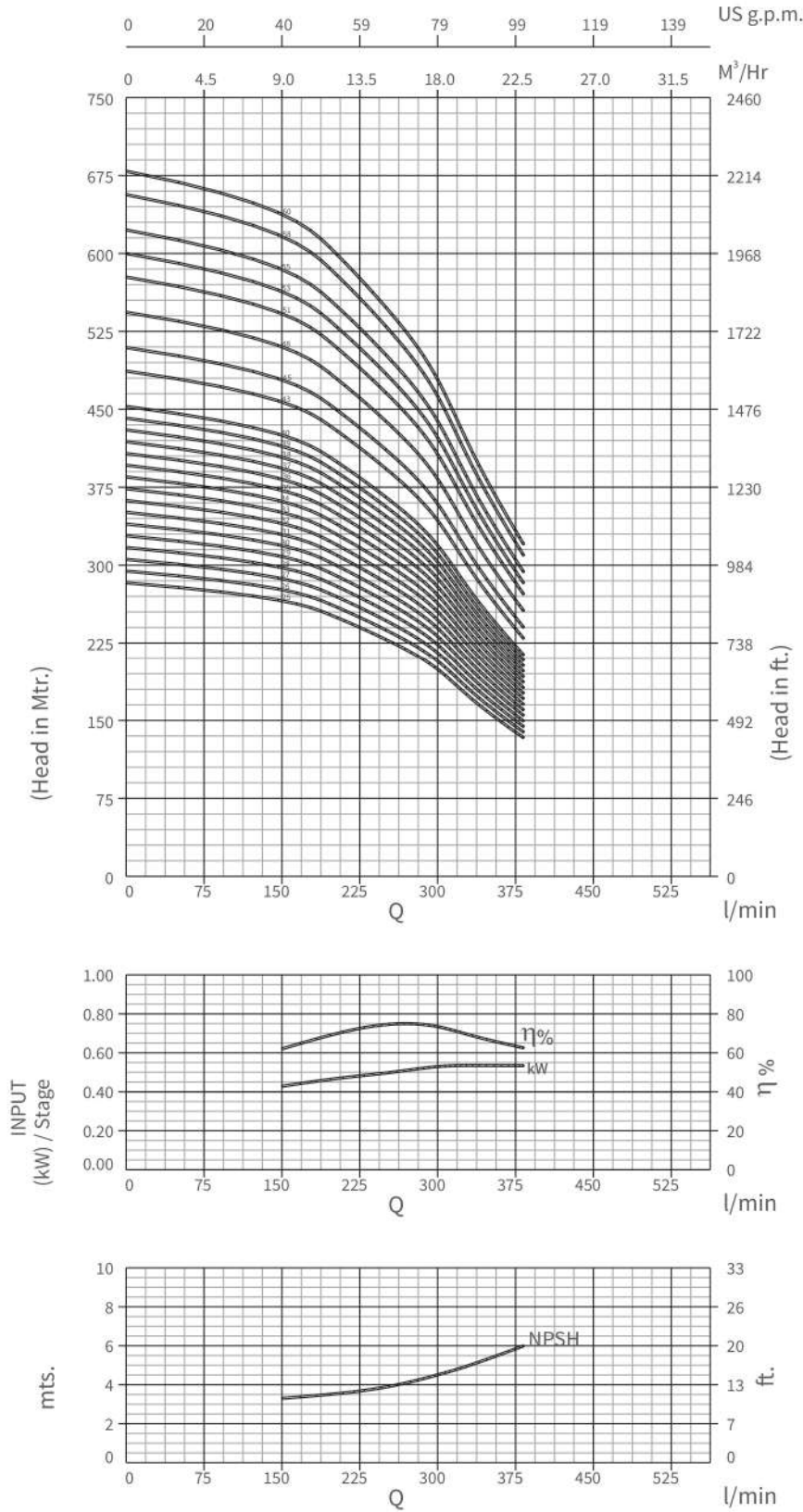

جدول عملکرد پمپ سری 6ESP 18,50Hz

MODEL NAME	STAGE	RATING		l/min m ³ /h	Discharge						
		kW	HP		0	150	200	250	300	333	383
THREE PHASE					0	150	200	250	300	333	383
					0	9	12	15	18	20	23

MODEL NAME	STAGE	kW	HP	HEAD IN Mtrs.	0	150	200	250	300	333	383
6 ESP 18-25	25	15.00	20.00		283	271	252	229	203	168	133
6 ESP 18-26	26	15.00	20.00		294	282	262	238	211	174	139
6 ESP 18-27	27	15.00	20.00		306	292	272	247	220	181	144
6 ESP 18-28	28	18.50	25.00		317	303	282	256	228	188	149
6 ESP 18-29	29	18.50	25.00		328	314	292	266	236	194	155
6 ESP 18-30	30	18.50	25.00		340	325	302	275	244	201	160
6 ESP 18-31	31	18.50	25.00		351	336	312	284	252	208	165
6 ESP 18-32	32	18.50	25.00		362	347	322	293	260	214	171
6 ESP 18-33	33	18.50	25.00		374	357	332	302	268	221	176
6 ESP 18-34	34	22.00	30.00		385	368	342	311	276	228	181
6 ESP 18-35	35	22.00	30.00		396	379	352	321	285	234	187
6 ESP 18-36	36	22.00	30.00		408	390	362	330	293	241	192
6 ESP 18-37	37	22.00	30.00		419	401	372	339	301	248	197
6 ESP 18-38	38	22.00	30.00		430	412	382	348	309	255	203
6 ESP 18-39	39	22.00	30.00		441	422	392	357	317	261	208
6 ESP 18-40	40	22.00	30.00		453	433	402	366	325	268	213
6 ESP 18-43	43	26.00	35.00		487	466	433	394	350	288	229
6 ESP 18-45	45	26.00	35.00		509	487	453	412	366	302	240
6 ESP 18-48	48	26.00	35.00		543	520	483	440	390	322	256
6 ESP 18-51	51	30.00	40.00		577	552	513	467	415	342	272
6 ESP 18-53	53	30.00	40.00		600	574	533	485	431	355	282
6 ESP 18-55	55	37.00	50.00		623	596	553	504	447	368	293
6 ESP 18-58	58	37.00	50.00		657	628	583	531	472	389	309
6 ESP 18-60	60	37.00	50.00		679	650	604	550	488	402	320

جدول وزن و ابعاد پمپ سری 6ESP 18,50Hz

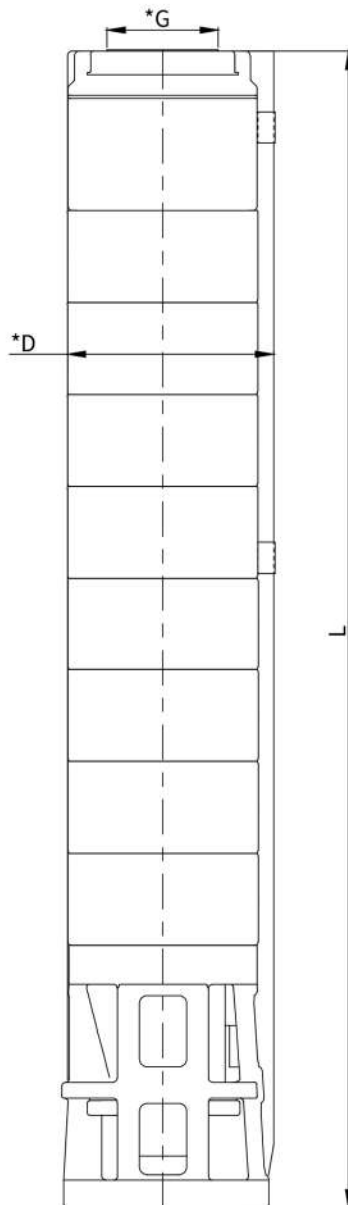

Model Name	Specification			
	*D (mm)	L (mm)	Pump Weight Kg.	Weight (Incl. pkg.) Kg.
6ESP-18 - 01	142	331	8	10
6ESP-18 - 02	142	392	9	11
6ESP-18 - 03	142	452	11	12
6ESP-18 - 04	142	513	12	13
6ESP-18 - 05	142	573	13	15
6ESP-18 - 06	142	634	14	16
6ESP-18 - 07	142	694	16	18
6ESP-18 - 08	142	755	17	19
6ESP-18 - 09	142	815	18	20
6ESP-18 - 10	142	876	19	21
6ESP-18 - 11	142	936	21	23
6ESP-18 - 12	142	997	22	24
6ESP-18 - 13	142	1057	23	26
6ESP-18 - 14	142	1118	24	27
6ESP-18 - 15	142	1178	26	28
6ESP-18 - 16	142	1239	27	30
6ESP-18 - 17	142	1299	28	31
6ESP-18 - 18	142	1360	29	32
6ESP-18 - 19	142	1420	31	34
6ESP-18 - 20	142	1481	32	35
6ESP-18 - 21	142	1541	33	37
6ESP-18 - 22	142	1602	34	38
6ESP-18 - 23	142	1662	36	39
6ESP-18 - 24	142	1723	37	40
6ESP-18 - 25	142	1783	38	42
6ESP-18 - 26	142	1844	39	43
6ESP-18 - 27	142	1904	41	44
6ESP-18 - 28	142	1965	42	45
6ESP-18 - 29	142	2025	43	47
6ESP-18 - 30	142	2086	44	48
6ESP-18 - 31	142	2146	46	50
6ESP-18 - 32	142	2207	47	51
6ESP-18 - 33	142	2267	48	52
6ESP-18 - 34	142	2328	49	53
6ESP-18 - 35	142	2388	51	55
6ESP-18 - 36	142	2449	52	56
6ESP-18 - 37	142	2509	53	57
6ESP-18 - 38	142	2570	54	58
6ESP-18 - 39	142	2630	56	60
6ESP-18 - 40	142	2691	57	61

*G : Available Outlet Size BSP 2.5"

*D : With Cable Guard

6VP-18 -01 to 6VP-18 -13 pumps are also available in 4" joining with outlet size BSP 2.5"

6VP-18 -43, 6VP-18 -45, 6VP-18 -48, 6VP-18 -51, 6VP-18 -53, 6VP-18 -55, 6VP-18 -58 & 6VP-18 -60 pumps are available in 6" joining with mounted sleeve & with outlet size BSP 3.0"

جدول وزن و ابعاد پمپ سری 6ESP 32

No	PART NAME	MATERIAL
1	N.R.V. 3.0"	S.S.304
2	VALVE	S.S.304
3	VALVE SEAT	N.B.R. + S.S.304
4	TOP & FIRST BEARING BUSH	N.B.R. + S.S.304
5	INTERMEDIATE CHAMBER TOP	S.S.304
6	NECKRING	N.B.R. + NYLON
7	BEARING BUSH	N.B.R.
8	INTER MEDIATE CHAMBER	S.S.304
9	COLLET NUT	S.S.304
10	IMPELLER	S.S.304
11	COLLET	S.S.304
12	PUMP SHAFT	S.S.431
13	INTER MEDIATE CHAMBER 1st	S.S.304
14	SPACING WASHER	25% CFT
15	CONNECTOR	S.S.304
16	STRAINER	S.S.304
17	CLAMPING STRIP	S.S.304
18	CABLE GUARD	S.S.304
19	NEMA COUPLING	S.S.304
20	SUCTION	S.S.304

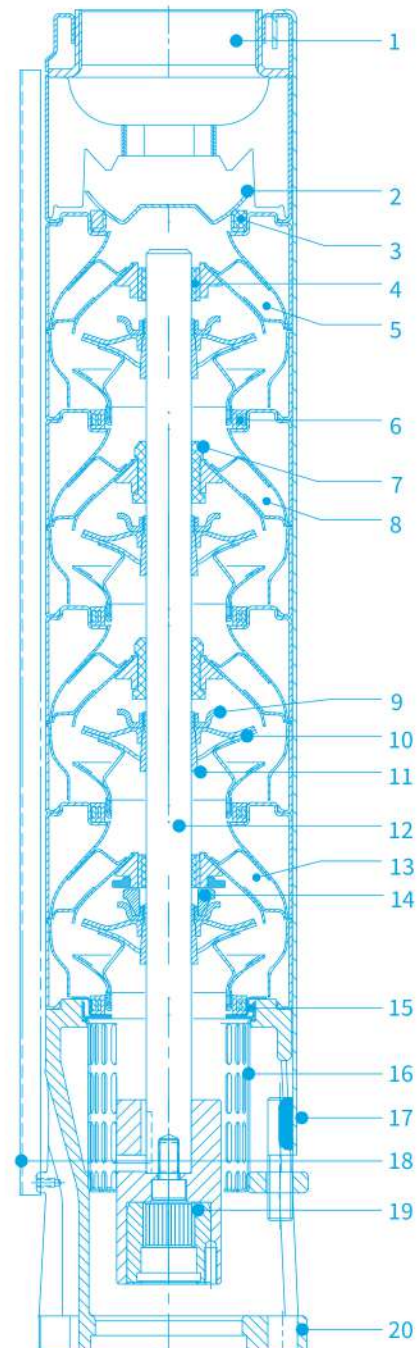

منحنی عملکرد پمپ سری 6ESP 32,50Hz

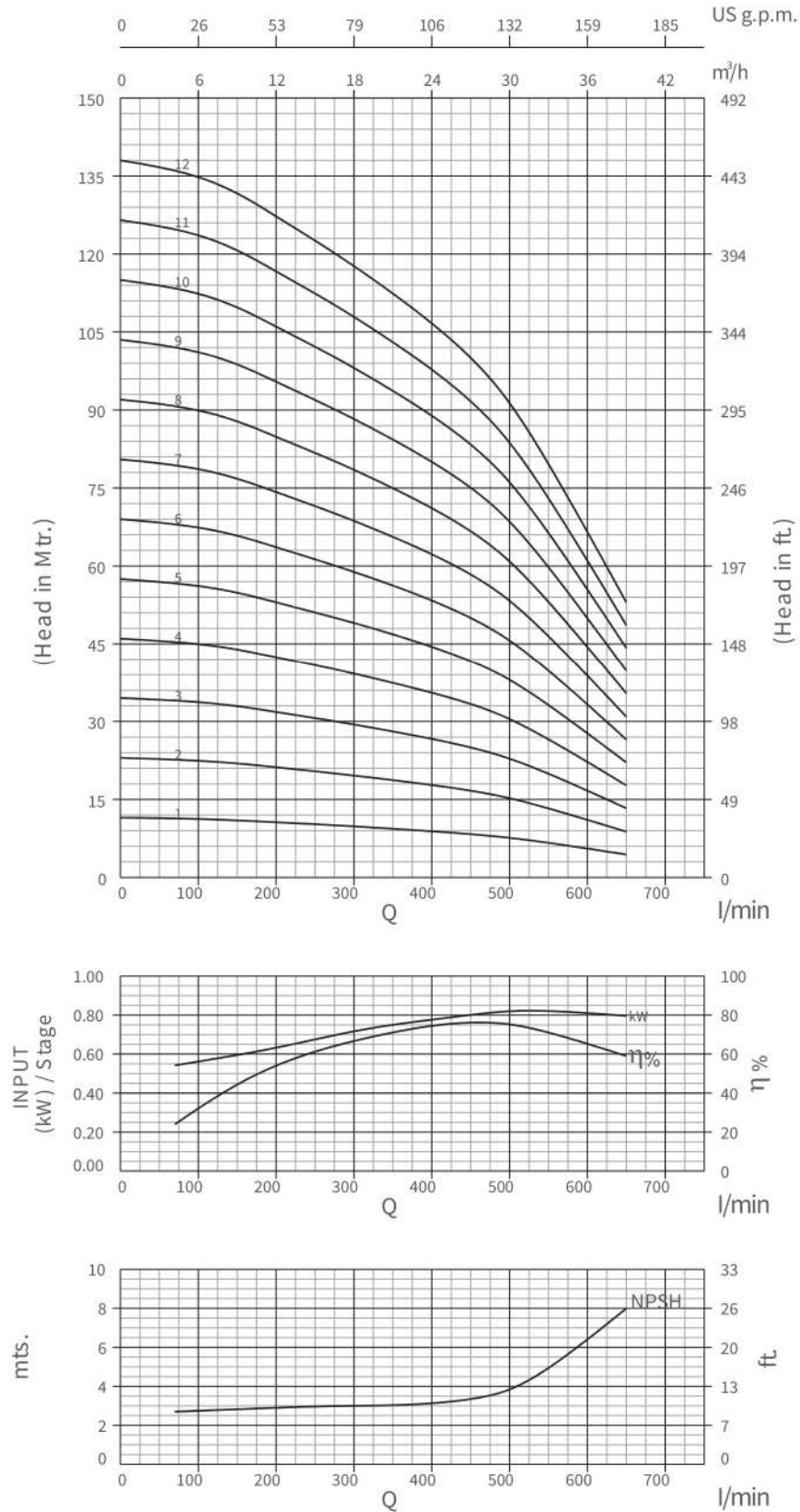

منحنی عملکرد پمپ سری 6ESP 32,50Hz

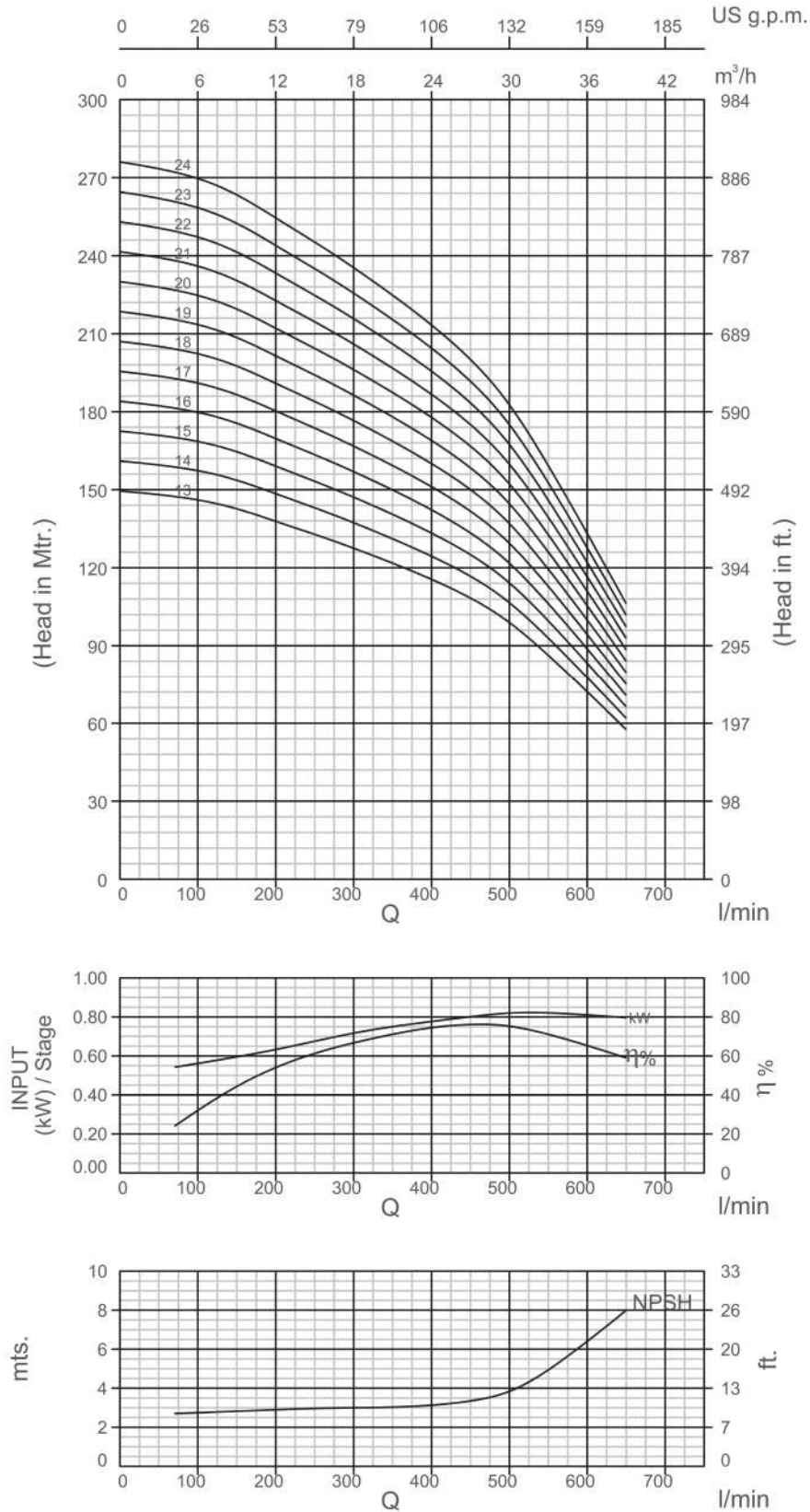

منحنی عملکرد پمپ سری 6ESP 32,50Hz

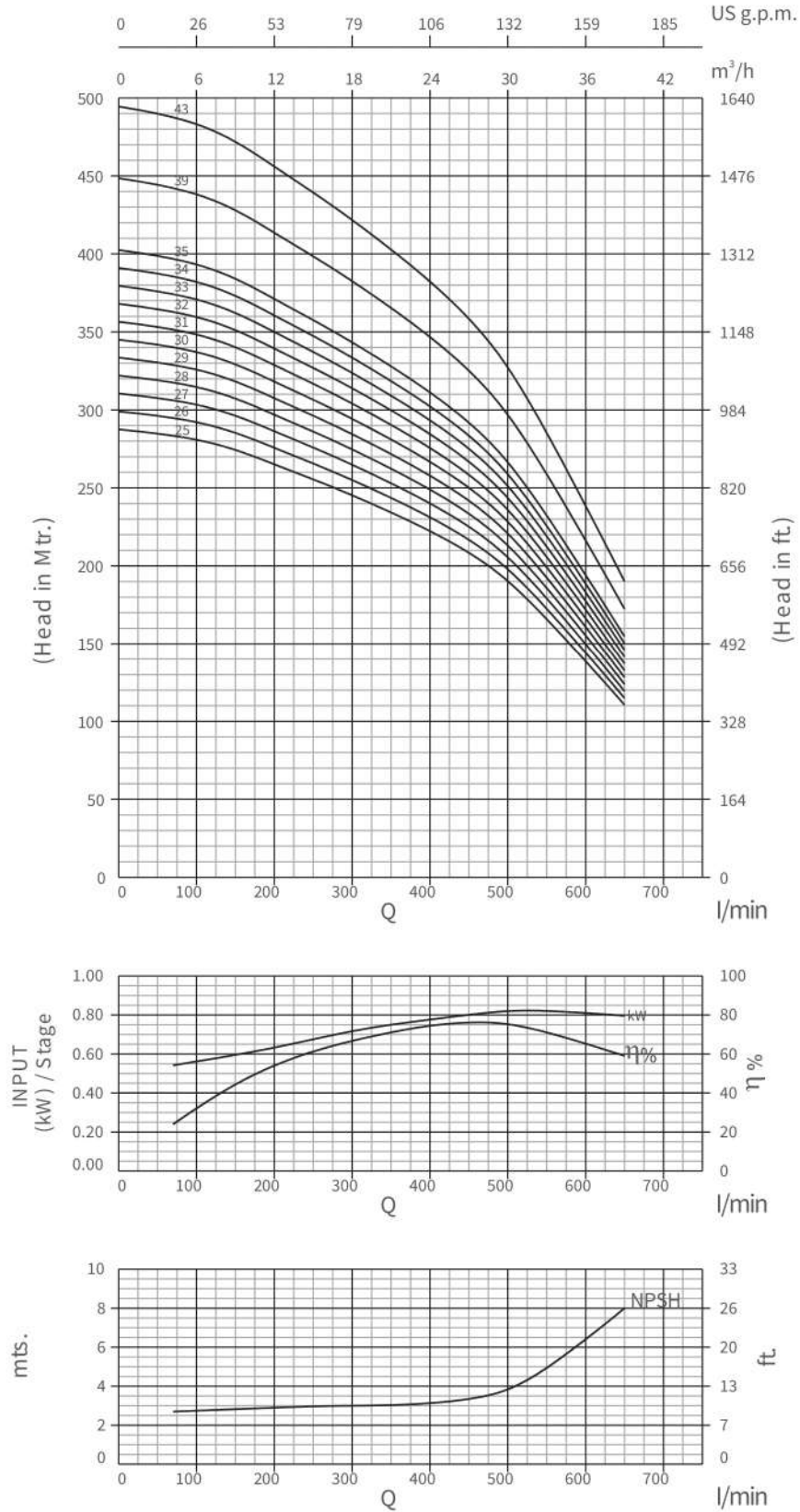

جدول عملکرد پمپ سری 6ESP 32,50Hz

Model Name	Stage	Rating		l/min m ³ /h	Discharge									
		kW	HP		0	70	135	200	270	335	400	470	535	650

Model Name	Stage	kW	HP	11.5	11.3	11	10.5	10	9.5	9	8	7	4
6ESP 32-01	1	1.10	1.50	23	22.5	22	21	20	19	18	16	14	9
6ESP 32-02	2	2.20	3.00	34.5	34	33	32	30	29	27	24	21	13
6ESP 32-03	3	3.00	4.00	46	45	44	42	40	38	36	33	28	18
6ESP 32-04	4	4.00	5.50	58	57	56	53	50	48	45	41	35	22
6ESP 32-05	5	5.50	7.50	69	68	67	64	60	57	53	49	42	27
6ESP 32-06	6	5.50	7.50	80.5	80	78	74	70	67	62	57	49	31
6ESP 32-07	7	7.50	10.00	92	91	89	85	81	76	71	65	56	35
6ESP 32-08	8	7.50	10.00	104	102	100	95	91	86	80	73	63	40
6ESP 32-09	9	9.30	12.50	115	114	111	106	101	95	89	81	70	44
6ESP 32-10	10	9.30	12.50	126	125	122	117	111	105	98	90	78	49
6ESP 32-11	11	9.30	12.50	138	136	133	127	121	114	107	98	85	53
6ESP 32-12	12	11.00	15.00	150	148	145	138	131	124	116	106	92	57
6ESP 32-13	13	11.00	15.00	161	159	156	148	141	133	125	114	99	62
6ESP 32-14	14	13.00	17.50	172	171	167	159	151	143	134	122	106	66
6ESP 32-15	15	13.00	17.50	184	182	178	170	161	152	143	130	113	71
6ESP 32-16	16	15.00	20.00	196	193	189	180	171	162	151	138	120	75
6ESP 32-17	17	15.00	20.00	207	205	200	191	181	171	160	147	127	80
6ESP 32-18	18	18.50	25.00	218	216	211	201	191	181	169	155	134	84
6ESP 32-19	19	18.50	25.00	230	227	222	212	201	190	178	163	141	88
6ESP 32-20	20	18.50	25.00	242	239	234	223	211	200	187	171	148	93
6ESP 32-21	21	18.50	25.00	253	250	245	233	222	209	196	179	155	97
6ESP 32-22	22	22.00	30.00	264	262	256	244	232	219	205	187	162	102
6ESP 32-23	23	22.00	30.00	276	273	267	254	242	228	214	195	169	106
6ESP 32-24	24	22.00	30.00	288	284	278	265	252	238	223	204	176	110
6ESP 32-25	25	22.00	30.00	299	296	289	276	262	247	232	212	183	115
6ESP 32-26	26	22.00	30.00	310	307	300	286	272	257	241	220	190	119
6ESP 32-27	27	26.00	35.00	322	318	311	297	282	266	249	228	197	124
6ESP 32-28	28	26.00	35.00	334	330	322	307	292	276	258	236	204	128
6ESP 32-29	29	26.00	35.00	345	341	334	318	302	285	267	244	212	133
6ESP 32-30	30	26.00	35.00	356	352	345	329	312	295	276	252	219	137
6ESP 32-31	31	26.00	35.00	368	364	356	339	322	304	285	260	226	141
6ESP 32-32	32	30.00	40.00	380	375	367	350	332	314	294	269	233	146
6ESP 32-33	33	30.00	40.00	391	387	378	360	342	323	303	277	240	150
6ESP 32-34	34	30.00	40.00	402	398	389	371	352	333	312	285	247	155
6ESP 32-35	35	30.00	40.00	448	443	434	413	393	371	347	317	275	172
6ESP 32-39	39	37.00	50.00	494	489	478	456	433	409	383	350	303	190
6ESP 32-43	43	37.00	50.00										

HEAD IN Mtrs.

جدول وزن و ابعاد پمپ سری 6ESP 32,50Hz

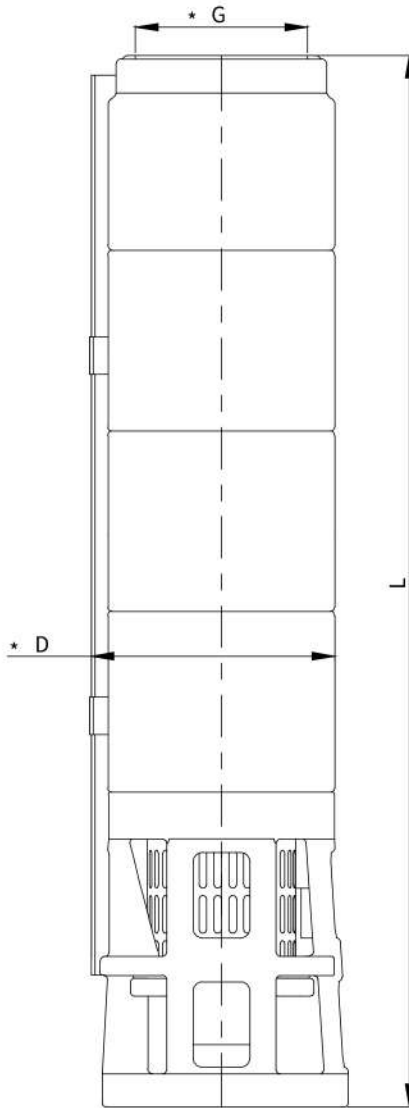

Model Name	Specification			
	*D (mm)	L (mm)	Pump Weight Kg.	Weight (Incl. pkg.) Kg.
6ESP32 - 01	142	367	9	14
6ESP32 - 02	142	463	11	16
6ESP32 - 03	142	559	13	18
6ESP32 - 04	142	655	15	20
6ESP32 - 05	142	751	11	16
6ESP32 - 06	142	847	19	24
6ESP32 - 07	142	943	21	26
6ESP32 - 08	142	1039	23	28
6ESP32 - 09	142	1135	25	30
6ESP32 - 10	142	1231	27	32
6ESP32 - 11	142	1327	29	34
6ESP32 - 12	142	1423	31	36
6ESP32 - 13	142	1519	33	38
6ESP32 - 14	142	1615	35	40
6ESP32 - 15	142	1711	37	47
6ESP32 - 16	142	1807	39	49
6ESP32 - 17	142	1903	41	51
6ESP32 - 18	142	1999	43	53
6ESP32 - 19	142	2095	45	55
6ESP32 - 20	142	2191	47	57
6ESP32 - 21	142	2287	49	59
6ESP32 - 22	142	2383	51	63
6ESP32 - 23	142	2479	53	65
6ESP32 - 24	142	2575	55	67
6ESP32 - 25	142	2671	57	69
6ESP32 - 26	142	2767	59	71
6ESP32 - 27	142	2863	61	73
6ESP32 - 28	142	2959	63	75
6ESP32 - 29	142	3055	65	77
6ESP32 - 30	142	3151	67	79
6ESP32 - 31	142	3247	69	81
6ESP32 - 32	142	3343	71	83
6ESP32 - 33	142	3439	73	85
6ESP32 - 34	142	3535	75	87
6ESP32 - 35	142	3631	77	89
6ESP32 - 39	182	4450	105	117
6ESP32 - 43	182	4834	113	125

*G : Available Outlet Size BSP 2.5" & 3.0"

*D : With Cable Guard

6VP 32 -01 to 6VP 32 -8 pumps are also available in 4" joining.

6VP 32 -39 & 6VP 32 -43 pumps are also available with mounted sleeve in 6" joining.

6VP 32 -46, 6VP 32 -49, 6VP 32 -52 & 6VP 32 -54 pumps are also available with mounted sleeve in 8" joining.

جدول مشخصات پمپ سری 6ESP 48 , 6ESP 62

No	PART NAME	MATERIAL
1	N.R.V. 4.0"	S.S.304
2	VALVE	S.S.304
3	TOP & FIRST BEARING BUSH	N.B.R. + S.S.304
4	INTERMEDIATE CHAMBER TOP	S.S.304
5	COLLET NUT	S.S.304
6	IMPELLER	S.S.304
7	COLLET	S.S.304
8	BEARING BUSH	NBR
9	INTERMEDIATE CHAMBER STAGE	S.S.304
10	NECKRING	N.B.R. + NYLON
11	INTERMEDIATE CHAMBER 1st	S.S.304
12	SPACING WASHER	25% CFT
13	FIRST STAGE NUT	S.S.304
14	PUMP SHAFT	S.S.431
15	CONNECTOR	S.S.304
16	CLAMPING STRIP	S.S.304
17	STRAINER	S.S.304
18	NEMA COUPLING	S.S.304
19	CABLE GUARD	S.S.304
20	SUCTION	S.S.304

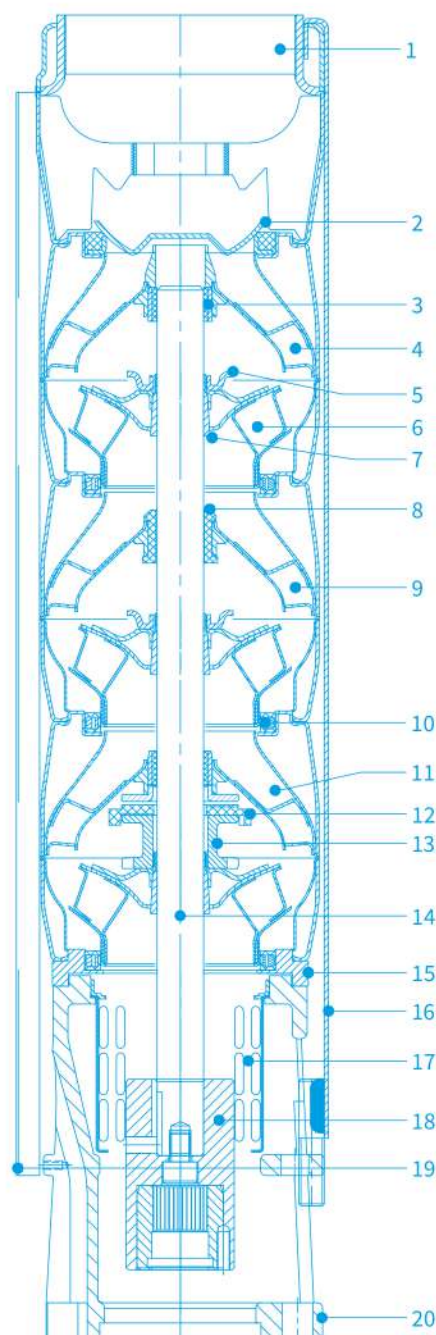

منحنی عملکرد پمپ سری 6ESP 48,50Hz

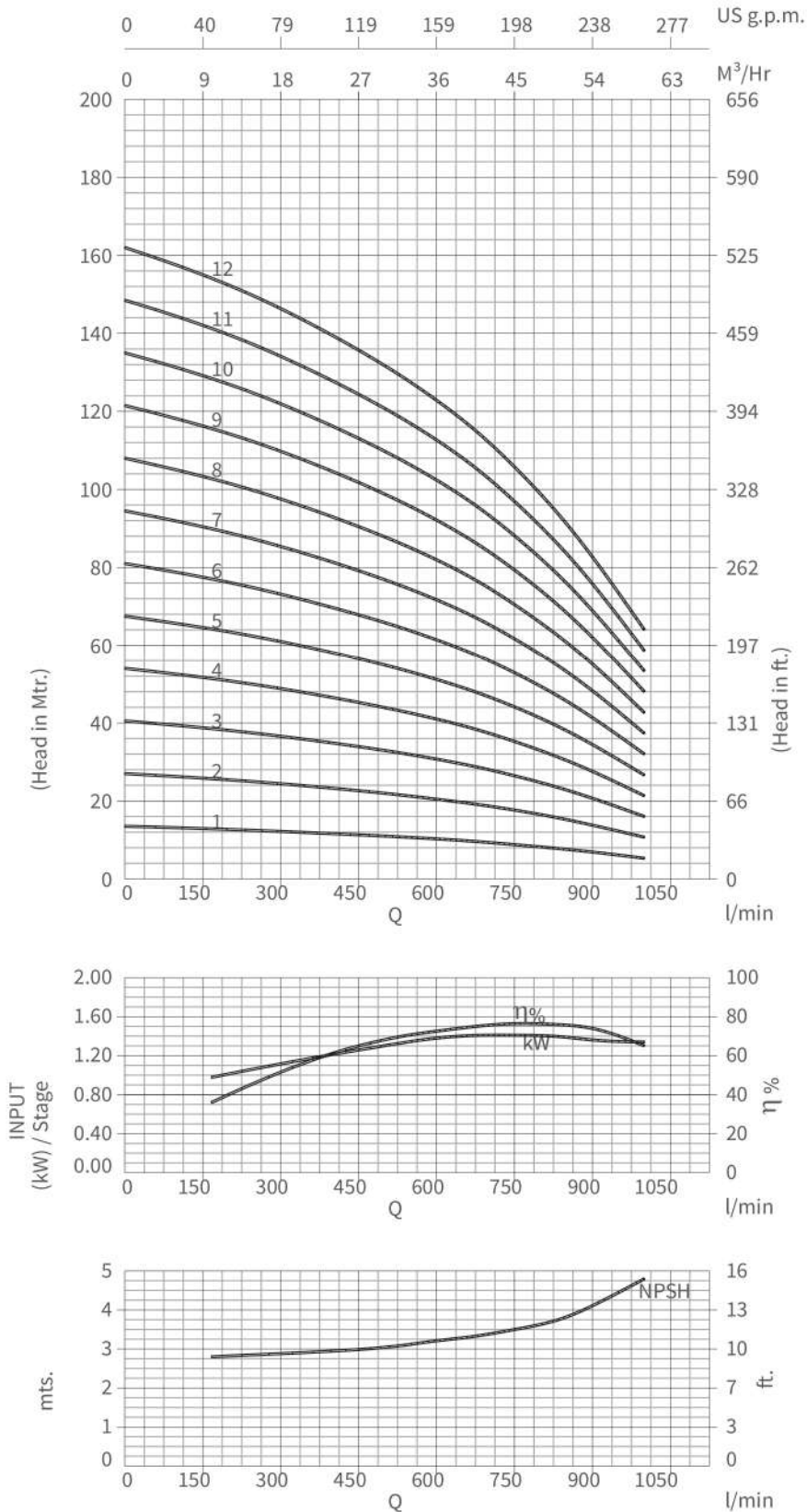

منحنی عملکرد پمپ سری 6ESP 48,50Hz

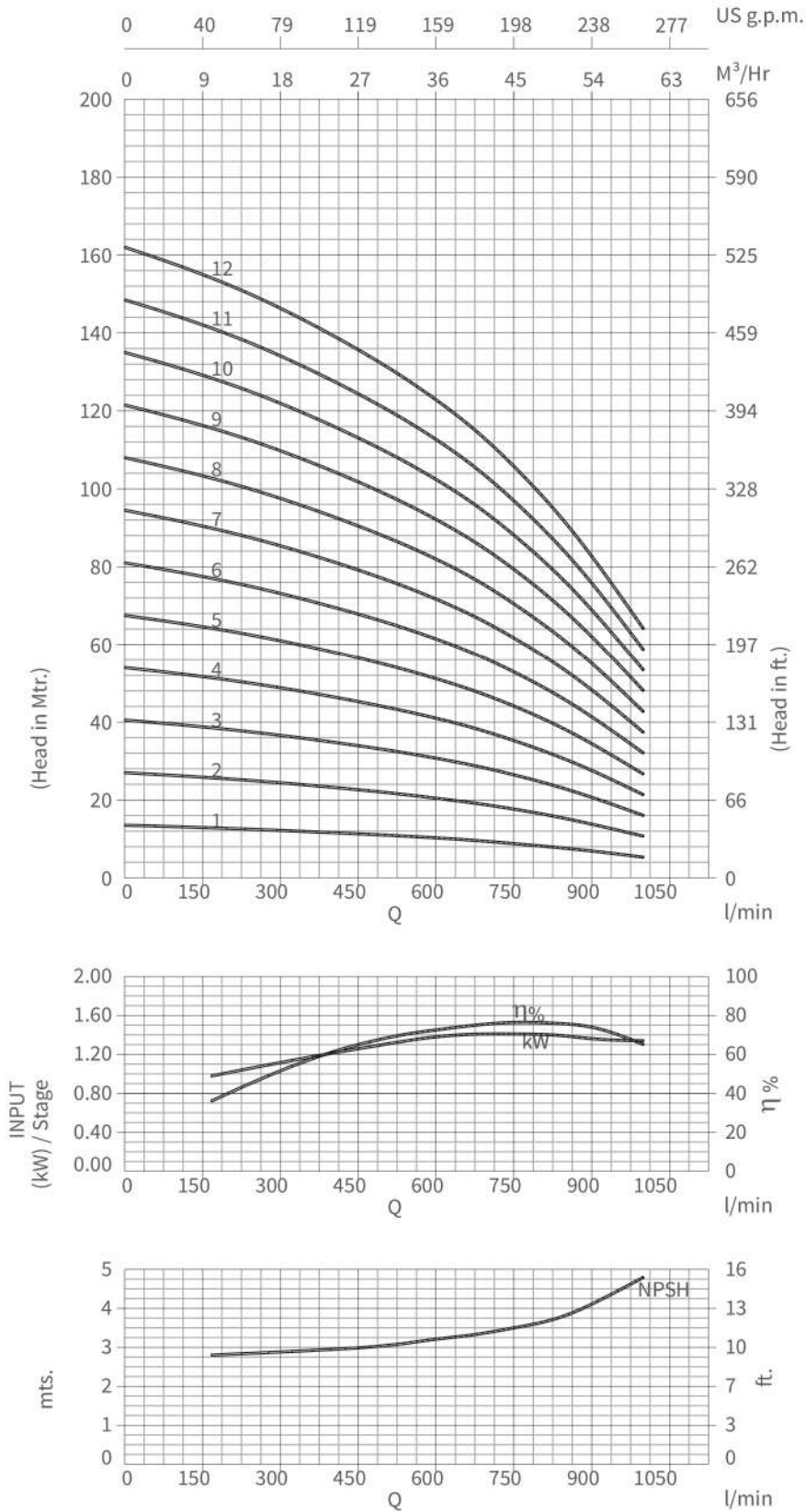

منحنی عملکرد پمپ سری 6ESP 48,50Hz

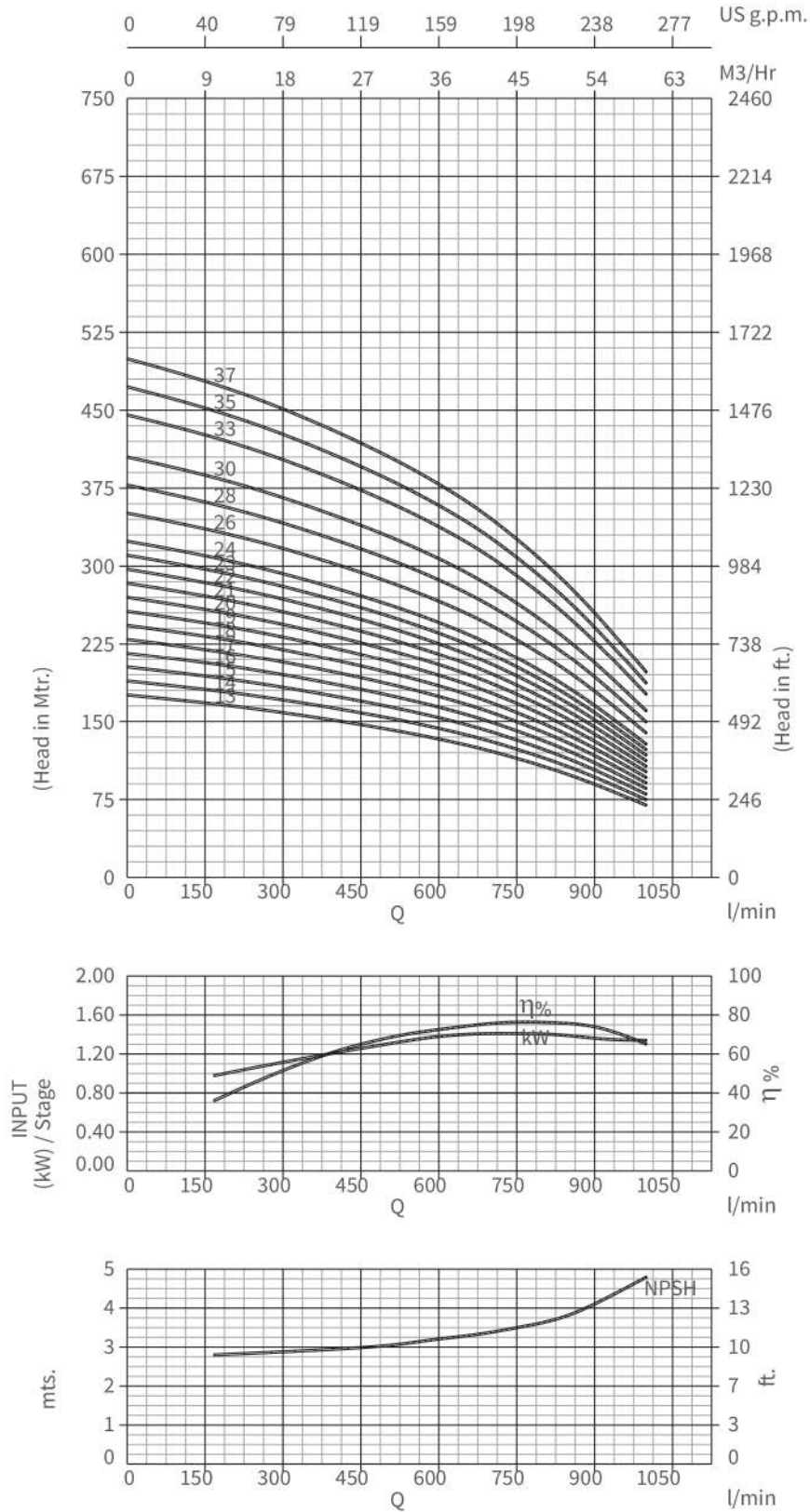

جدول عملکرد پمپ سری 6ESP 48,50Hz

MODEL NAME	STAGE	RATING		DISCHARGE										
		kW	HP	l/min	0	167	335	500	585	670	750	835	917	1000
				m ³ /h	0	10.0	20.1	30.0	35.1	40.2	45.0	50.1	55.0	60.0

MODEL NAME	STAGE	kW	HP	HEAD IN Mtrs.	14	13	12	11	10	9.5	9	8	7	5
6 ESP 48-01	1	2.20	3.00		14	13	12	11	10	9.5	9	8	7	5
6 ESP 48-02	2	3.00	4.00		27	26	24	22	21	19	18	16	13	11
6 ESP 48-03	3	5.50	7.50		40	39	36	33	31	29	26	23	20	16
6 ESP 48-04	4	7.50	10.00		54	52	48	44	41	39	35	31	27	21
6 ESP 48-05	5	7.50	10.00		68	64	60	55	52	48	44	39	33	27
6 ESP 48-06	6	9.30	12.50		81	77	72	66	62	58	53	47	40	32
6 ESP 48-07	7	11.00	15.00		94	90	84	77	73	68	62	55	47	37
6 ESP 48-08	8	13.00	17.50		108	103	96	88	83	77	71	63	53	43
6 ESP 48-09	9	15.00	20.00		122	116	108	99	93	87	79	70	60	48
6 ESP 48-10	10	15.00	20.00		135	129	120	110	104	97	88	78	67	53
6 ESP 48-11	11	18.50	25.00		148	142	132	121	114	106	97	86	73	59
6 ESP 48-12	12	18.50	25.00		162	155	144	132	124	116	106	94	80	64
6 ESP 48-13	13	22.00	30.00		176	168	157	143	135	126	115	102	87	69
6 ESP 48-14	14	22.00	30.00		189	181	169	154	145	135	124	110	93	75
6 ESP 48-15	15	22.00	30.00		202	194	181	165	156	145	132	117	100	80
6 ESP 48-16	16	26.00	35.00		216	206	193	176	166	155	141	125	107	85
6 ESP 48-17	17	26.00	35.00		230	219	205	187	176	164	150	133	113	91
6 ESP 48-18	18	30.00	40.00		243	232	217	198	187	174	159	141	120	96
6 ESP 48-19	19	30.00	40.00		256	245	229	209	197	184	168	149	127	101
6 ESP 48-20	20	30.00	40.00		270	258	241	220	207	193	177	157	133	107
6 ESP 48-21	21	37.00	50.00		284	271	253	231	218	203	185	164	140	112
6 ESP 48-22	22	37.00	50.00		297	284	265	242	228	213	194	172	147	117
6 ESP 48-23	23	37.00	50.00		310	297	277	253	239	222	203	180	153	123
6 ESP 48-24	24	37.00	50.00		324	310	289	264	249	232	212	188	160	128
6 ESP 48-26	26	45.00	60.00		351	335	313	286	270	251	230	204	173	139
6 ESP 48-28	28	45.00	60.00		378	361	337	308	290	271	247	219	187	149
6 ESP 48-30	30	45.00	60.00		405	387	361	330	311	290	265	235	200	160
6 ESP 48-33	33	55.00	75.00		446	426	397	363	342	319	291	258	220	176
6 ESP 48-35	35	55.00	75.00		472	452	421	385	363	338	309	274	233	187
6 ESP 48-37	37	63.00	85.00		500	477	445	407	384	358	327	290	247	197

جدول عملکرد پمپ سری 6ESP 48,50Hz

MODEL NAME	STAGE	RATING		DISCHARGE										
		kW	HP	l/min	0	167	335	500	585	670	750	835	917	1000
				m ³ /h	0	10.0	20.1	30.0	35.1	40.2	45.0	50.1	55.0	60.0

MODEL NAME	STAGE	kW	HP	HEAD IN Mtrs.	14	13	12	11	10	9.5	9	8	7	5
6 ESP 48-01	1	2.20	3.00		14	13	12	11	10	9.5	9	8	7	5
6 ESP 48-02	2	3.00	4.00		27	26	24	22	21	19	18	16	13	11
6 ESP 48-03	3	5.50	7.50		40	39	36	33	31	29	26	23	20	16
6 ESP 48-04	4	7.50	10.00		54	52	48	44	41	39	35	31	27	21
6 ESP 48-05	5	7.50	10.00		68	64	60	55	52	48	44	39	33	27
6 ESP 48-06	6	9.30	12.50		81	77	72	66	62	58	53	47	40	32
6 ESP 48-07	7	11.00	15.00		94	90	84	77	73	68	62	55	47	37
6 ESP 48-08	8	13.00	17.50		108	103	96	88	83	77	71	63	53	43
6 ESP 48-09	9	15.00	20.00		122	116	108	99	93	87	79	70	60	48
6 ESP 48-10	10	15.00	20.00		135	129	120	110	104	97	88	78	67	53
6 ESP 48-11	11	18.50	25.00		148	142	132	121	114	106	97	86	73	59
6 ESP 48-12	12	18.50	25.00		162	155	144	132	124	116	106	94	80	64
6 ESP 48-13	13	22.00	30.00		176	168	157	143	135	126	115	102	87	69
6 ESP 48-14	14	22.00	30.00		189	181	169	154	145	135	124	110	93	75
6 ESP 48-15	15	22.00	30.00		202	194	181	165	156	145	132	117	100	80
6 ESP 48-16	16	26.00	35.00		216	206	193	176	166	155	141	125	107	85
6 ESP 48-17	17	26.00	35.00		230	219	205	187	176	164	150	133	113	91
6 ESP 48-18	18	30.00	40.00		243	232	217	198	187	174	159	141	120	96
6 ESP 48-19	19	30.00	40.00		256	245	229	209	197	184	168	149	127	101
6 ESP 48-20	20	30.00	40.00		270	258	241	220	207	193	177	157	133	107
6 ESP 48-21	21	37.00	50.00		284	271	253	231	218	203	185	164	140	112
6 ESP 48-22	22	37.00	50.00		297	284	265	242	228	213	194	172	147	117
6 ESP 48-23	23	37.00	50.00		310	297	277	253	239	222	203	180	153	123
6 ESP 48-24	24	37.00	50.00		324	310	289	264	249	232	212	188	160	128
6 ESP 48-26	26	45.00	60.00		351	335	313	286	270	251	230	204	173	139
6 ESP 48-28	28	45.00	60.00		378	361	337	308	290	271	247	219	187	149
6 ESP 48-30	30	45.00	60.00		405	387	361	330	311	290	265	235	200	160
6 ESP 48-33	33	55.00	75.00		446	426	397	363	342	319	291	258	220	176
6 ESP 48-35	35	55.00	75.00		472	452	421	385	363	338	309	274	233	187
6 ESP 48-37	37	63.00	85.00		500	477	445	407	384	358	327	290	247	197

جدول وزن و ابعاد پمپ سری 6ESP 48,50Hz

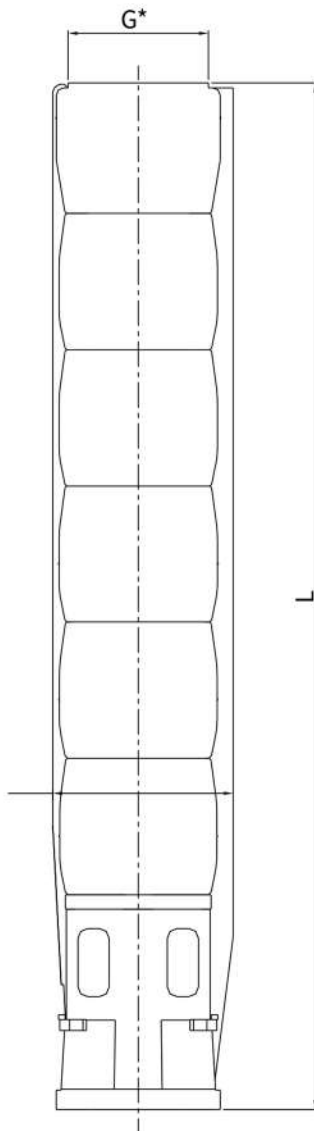

Model Name	Specification			
	D (mm)	L (mm)	Pump Weight Kg.	WEIGHT (incl.pkg.) kg.
6 ESP 48-01	147	113	12	15
6 ESP 48-02	147	509	14	17
6 ESP 48-03	147	622	16	14
6 ESP 48-04	147	735	18	21
6 ESP 48-05	147	848	20	24
6 ESP 48-06	147	961	18	23
6 ESP 48-07	147	1074	20	25
6 ESP 48-08	147	1187	22	28
6 ESP 48-09	147	1300	24	29
6 ESP 48-10	147	1413	26	34
6 ESP 48-11	147	1526	28	36
6 ESP 48-12	147	1639	32	42
6 ESP 48-13	147	1752	34	44
6 ESP 48-14	147	1865	36	46
6 ESP 48-15	147	1978	38	48
6 ESP 48-16	147	2091	40	50
6 ESP 48-17	147	2204	42	52
6 ESP 48-18	147	2317	44	54
6 ESP 48-19	147	2430	46	56
6 ESP 48-20	147	2543	48	58
6 ESP 48-21	147	2656	55	60
6 ESP 48-22	147	2769	57	62
6 ESP 48-23	147	2882	60	65
6 ESP 48-24	147	2995	62	67

*G : Available outlet size 3" & 4"

*D : With cable Guard

6VP 48 -1 to 6VP 48-5 pumps are also available in 4" Joining.

6VP 48 -26, 6VP 48 -28, 6VP 48-30, 6VP 48-33, 6VP 48-35

& 6VP 48-37 pumps are available in 8" Joining with mounted sleeve.

منحنی عملکرد پمپ سری 6ESP 62,50Hz

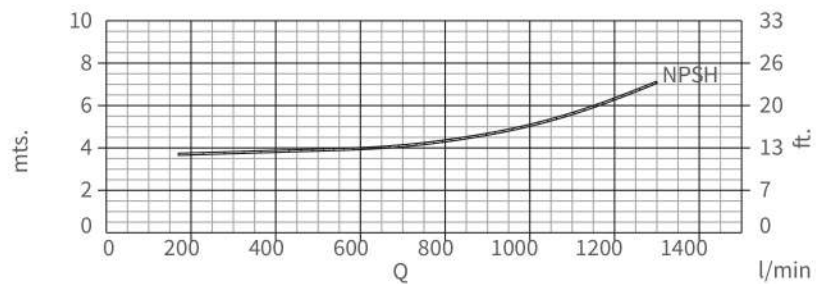
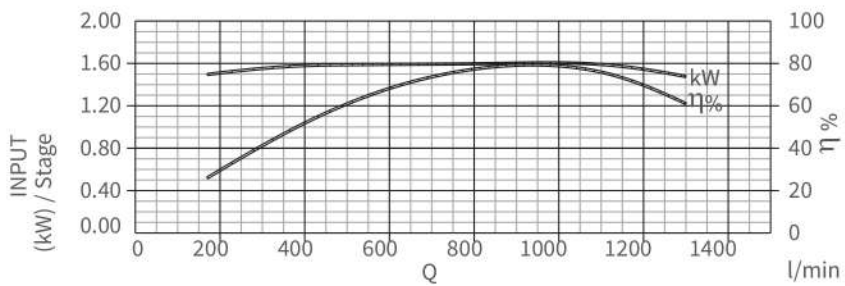
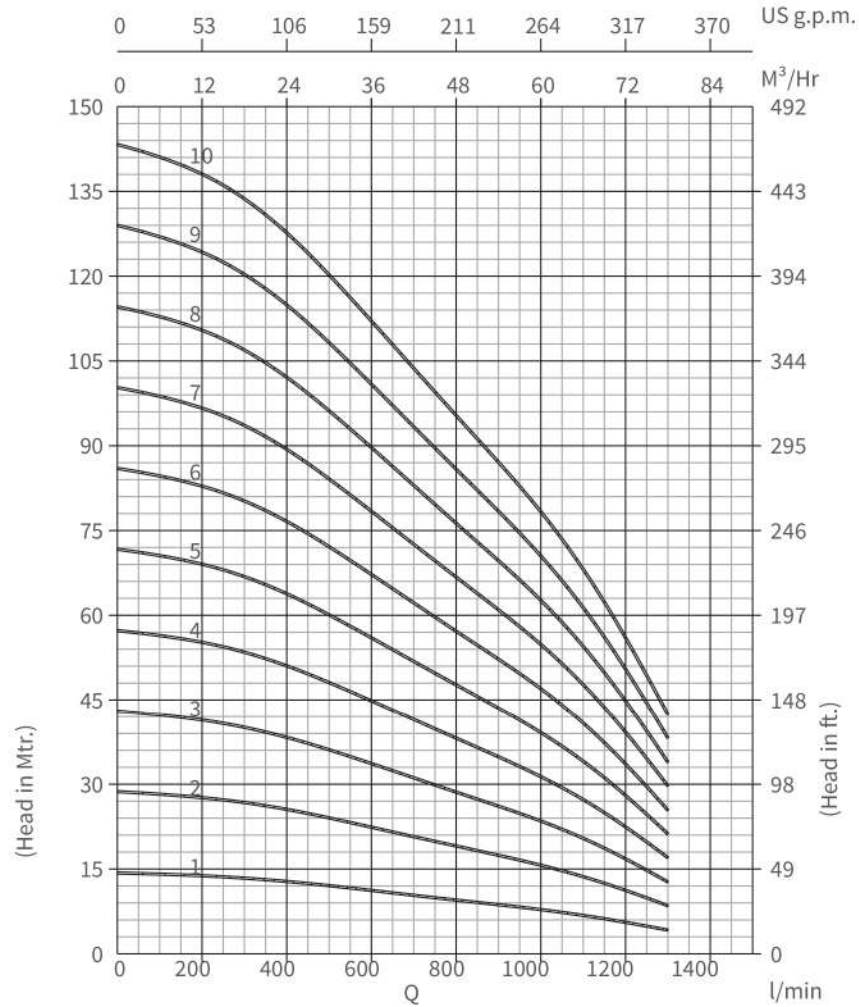

منحنی عملکرد پمپ سری 6ESP 62,50Hz

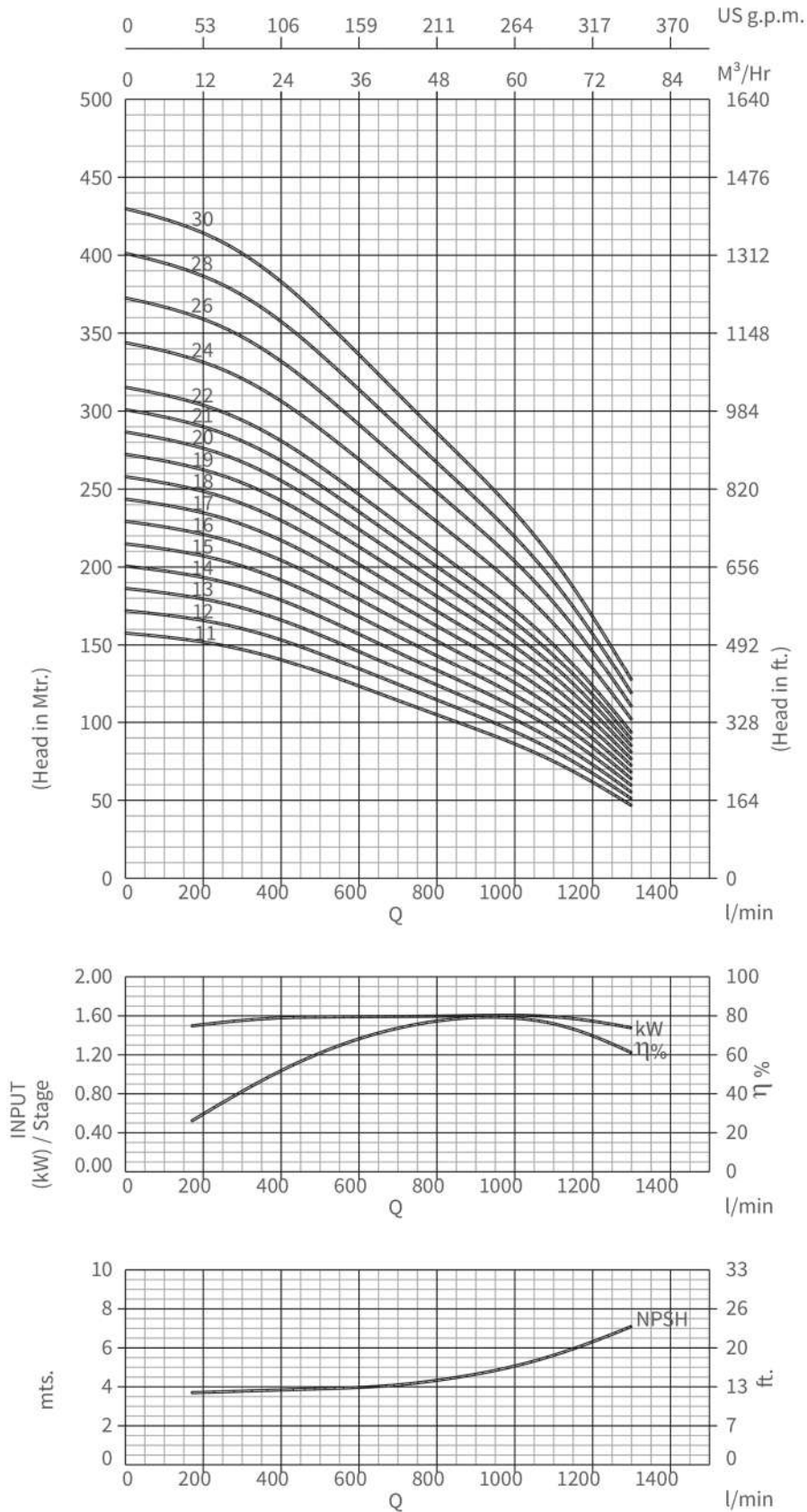

جدول عملکرد پمپ سری 6ESP 62,50Hz

MODEL NAME	STAGE	RATING		DISCHARGE									
		kW	HP	l/min	0	170	335	500	670	835	1000	1167	1300
				m ³ /h	0	10.2	20.1	30.1	40.2	50.1	60.0	70.0	78.0

MODEL NAME	STAGE	kW	HP	14.5	14	13	12	11	9	8	6	4
6 ESP 62-01	1	2.20	3.00	14.5	14	13	12	11	9	8	6	4
6 ESP 62-02	2	4.00	5.50	29	28	27	24	21	18	16	12	8
6 ESP 62-03	3	5.50	7.50	43	42	40	36	32	28	24	18	13
6 ESP 62-04	4	7.50	10.00	57	56	53	48	42	37	32	25	17
6 ESP 62-05	5	9.30	12.50	72	70	66	60	53	46	40	31	21
6 ESP 62-06	6	11.00	15.00	86	84	80	72	64	55	47	37	25
6 ESP 62-07	7	13.00	17.50	100	98	93	84	74	65	55	43	30
6 ESP 62-08	8	15.00	20.00	115	112	106	96	85	74	63	49	34
6 ESP 62-09	9	18.50	25.00	129	126	120	108	96	83	71	55	38
6 ESP 62-10	10	18.50	25.00	143	140	133	120	106	92	79	61	42
6 ESP 62-11	11	22.00	30.00	158	154	146	133	117	102	87	68	47
6 ESP 62-12	12	22.00	30.00	172	168	159	145	127	111	95	74	51
6 ESP 62-13	13	26.00	35.00	186	182	173	157	138	120	103	80	55
6 ESP 62-14	14	26.00	35.00	201	196	186	169	149	129	111	86	59
6 ESP 62-15	15	26.00	35.00	215	210	199	181	159	139	118	92	64
6 ESP 62-16	16	30.00	40.00	229	224	212	193	170	148	126	98	68
6 ESP 62-17	17	30.00	40.00	244	238	226	205	181	157	134	104	72
6 ESP 62-18	18	37.00	50.00	258	252	239	217	191	166	142	111	76
6 ESP 62-19	19	37.00	50.00	272	266	252	229	202	176	150	117	81
6 ESP 62-20	20	37.00	50.00	287	280	266	241	212	185	158	123	85
6 ESP 62-21	21	37.00	50.00	301	294	279	253	223	194	166	129	89
6 ESP 62-22	22	45.00	60.00	315	308	292	265	234	203	174	135	93
6 ESP 62-24	24	45.00	60.00	344	336	319	289	255	222	190	147	102
6 ESP 62-26	26	55.00	75.00	373	364	345	313	276	240	205	160	110
6 ESP 62-28	28	55.00	75.00	401	392	372	337	297	259	221	172	119
6 ESP 62-30	30	55.00	75.00	430	420	398	362	319	277	237	184	127

HEAD IN Mtrs.

جدول وزن و ابعاد پمپ سری 6ESP 62,50Hz

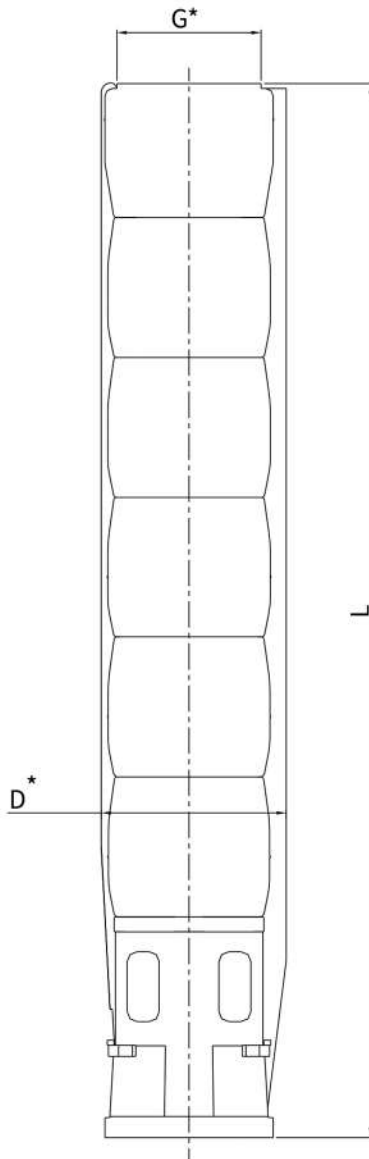

Model Name	Specification			
	D (mm)	L (mm)	Pump Weight Kg.	Weight (incl.pkg.) kg.
6 ESP 62-01	147	113	12	15
6 ESP 62-02	147	509	14	17
6 ESP 62-03	147	622	16	14
6 ESP 62-04	147	735	18	21
6 ESP 62-05	147	848	20	24
6 ESP 62-06	147	961	18	23
6 ESP 62-07	147	1074	20	25
6 ESP 62-08	147	1187	22	28
6 ESP 62-09	147	1300	24	29
6 ESP 62-10	147	1413	26	34
6 ESP 62-11	147	1526	28	36
6 ESP 62-12	147	1639	32	42
6 ESP 62-13	147	1752	34	44
6 ESP 62-14	147	1865	36	46
6 ESP 62-15	147	1978	38	48
6 ESP 62-16	147	2091	40	50
6 ESP 62-17	147	2204	42	52
6 ESP 62-18	147	2317	44	54
6 ESP 62-19	147	2430	46	56
6 ESP 62-20	147	2543	48	58
6 ESP 62-21	147	2656	50	60

*G : Available outlet size 3" & 4"

*D : With cable Guard

6VP 62 -1 to 6VP 62 -3 pumps are also available in 4" Joining.

6VP 62 -22, 6VP 62 -24, 6VP 62 -25, 6VP 62 -28 &

6VP 62 -30 pumps are available in 8" Joining.

جدول مشخصات پمپ سری 8ESP 80, 8ESP 98

NO	PART NAME	MATERIAL	STANDARD
1	DCH SLEEVE	STAINLESS STEEL	304
2	CLAMPING STRIP	STAINLESS STEEL	304
3	SPRING	STAINLESS STEEL	304
4	VALVE GUIDE RIB ASSEMBLY	STAINLESS STEEL	304
5	VALVE ASSEMBLY	STAINLESS STEEL	304
6	VALVE SEAT HOUSING	STAINLESS STEEL	304
7	FIRST STAGE BEARING BUSH	STAINLESS STEEL + NBR	304
8	STOP RING	STAINLESS STEEL	304
9	SPACING WASHER	25% CFT	304
10	FIRST STAGE NUT	STAINLESS STEEL	304
11	IMPELLER COLLET	STAINLESS STEEL	304
12	BEARING BUSH STAGE	NBR	
13	COLLET NUT	STAINLESS STEEL	304
14	NECKRING	NBR + PPS	
15	IMC SLEEVE	STAINLESS STEEL	304
16	INTERMEDIATE CHAMBER	STAINLESS STEEL	304
17	IMPELLER ASSEMBLY	STAINLESS STEEL	304
18	CABLE GUARD	STAINLESS STEEL	304
19	SHAFT	STAINLESS STEEL	431
20	STRAINER	STAINLESS STEEL	304
21	NEMA COUPLING	STAINLESS STEEL	304
22	SUCTION INTERCONNECTOR	STAINLESS STEEL	304

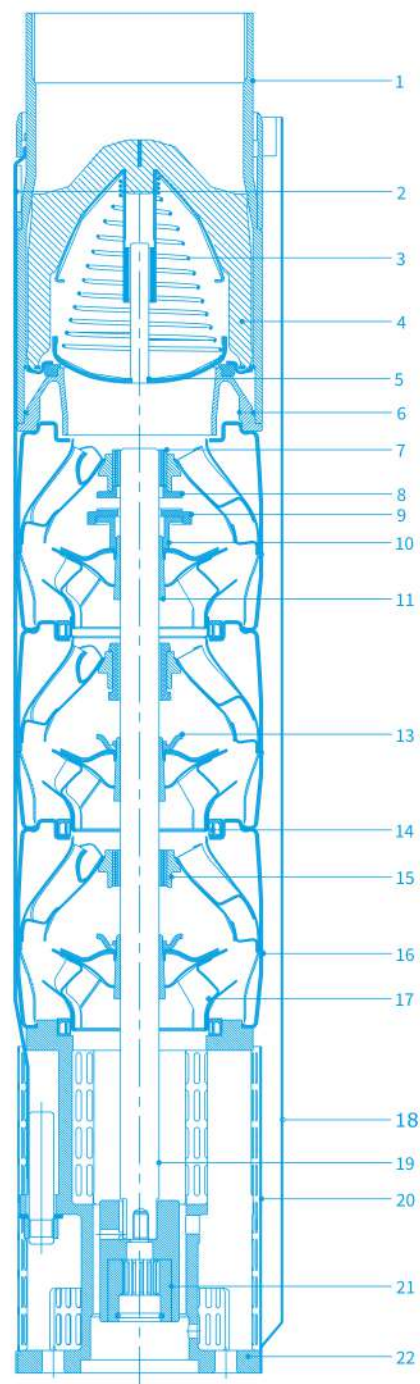

منحنی عملکرد پمپ سری 8ESP 80,50Hz

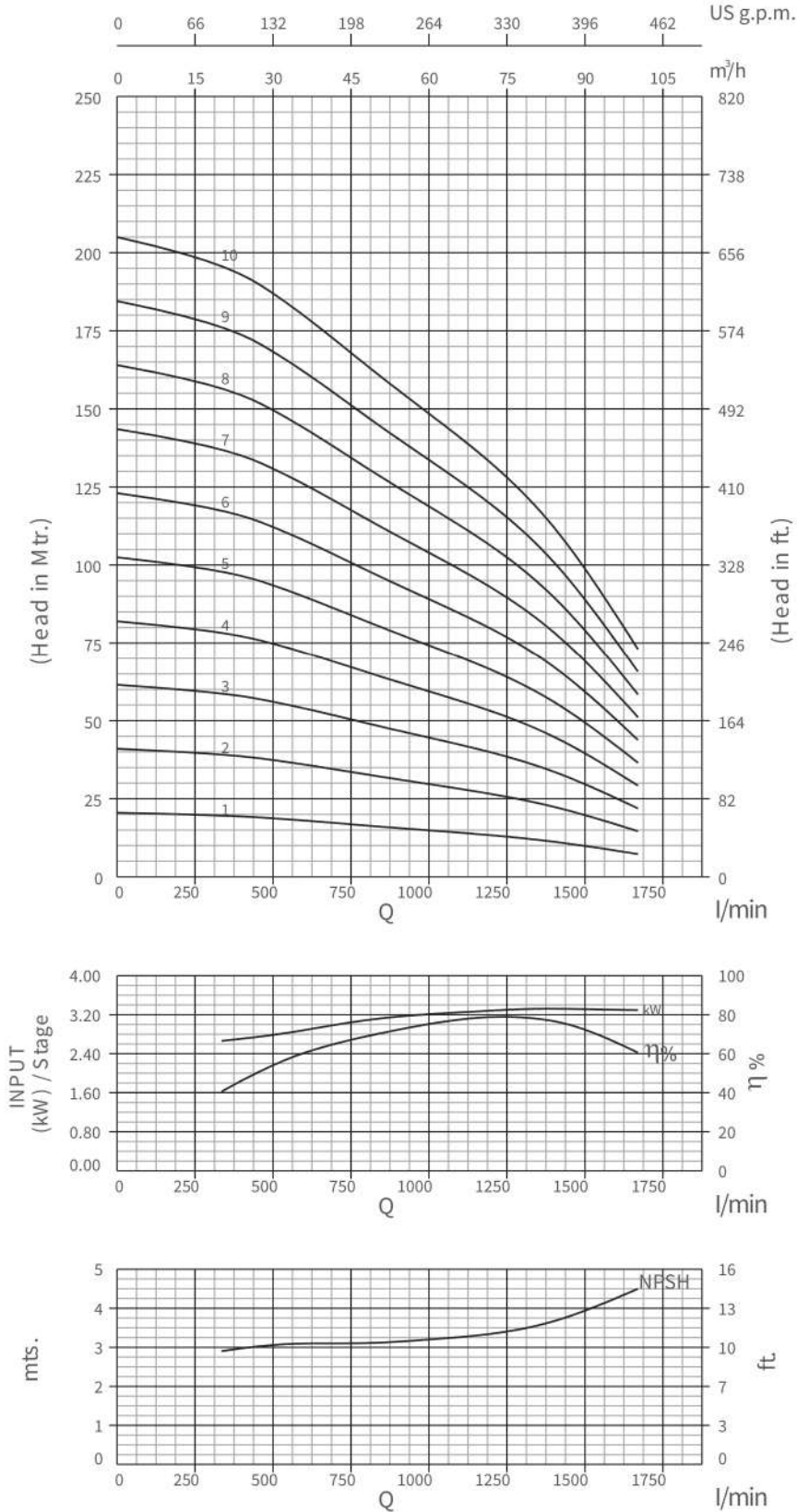

منحنی عملکرد پمپ سری 8ESP 80,50Hz

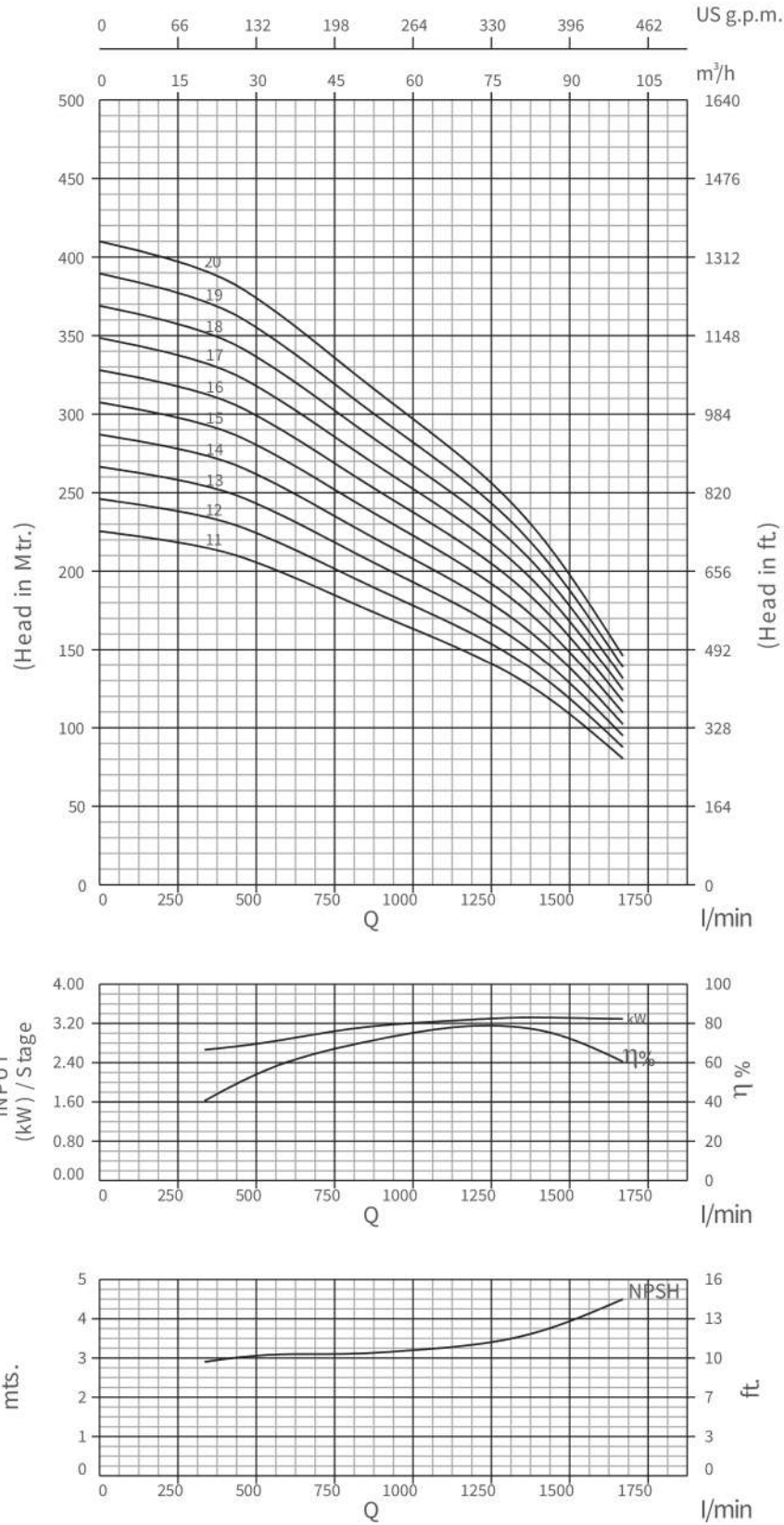

جدول عملکرد پمپ سری 8ESP 80,50Hz

Model Name	Stage	Rating		l/min m ³ /h	Discharge									
		kW	HP		0	335	500	670	835	1000	1170	1335	1500	1670
Three Phase					0	20.0	30.0	40.2	50.1	60.0	70.2	80.1	90.0	100.0

Model Name	Stage	kW	HP	HEAD IN Mtrs.	20.5	20	19	17	16	15	14	12	10	7
8 ESP 80-01	1	5.50	7.50		20.5	20	19	17	16	15	14	12	10	7
8 ESP 80-02	2	7.50	10.00		41	40	38	35	32	30	27	24	20	15
8 ESP 80-03	3	11.00	15.00		62	59	56	52	48	45	41	36	30	22
8 ESP 80-04	4	15.00	20.00		82	79	75	70	64	59	54	48	40	29
8 ESP 80-05	5	18.50	25.00		102	99	94	87	80	74	68	60	50	36
8 ESP 80-06	6	22.00	30.00		123	118	112	105	97	89	81	72	60	44
8 ESP 80-07	7	26.00	35.00		144	138	131	122	113	104	95	84	70	51
8 ESP 80-08	8	30.00	40.00		164	158	150	140	129	119	108	96	80	58
8 ESP 80-09	9	30.00	40.00		184	178	169	157	145	134	122	108	90	66
8 ESP 80-10	10	37.00	50.00		205	198	188	174	161	148	136	120	100	73
8 ESP 80-11	11	37.00	50.00		226	217	206	192	177	163	149	133	110	80
8 ESP 80-12	12	45.00	60.00		246	237	225	209	193	178	163	145	120	88
8 ESP 80-13	13	55.00	75.00		266	257	244	227	209	193	176	157	130	95
8 ESP 80-14	14	55.00	75.00		287	276	262	244	225	208	190	169	140	102
8 ESP 80-15	15	55.00	75.00		308	296	281	262	242	223	203	181	150	110
8 ESP 80-16	16	63.00	85.00		328	316	300	279	258	238	217	193	160	117
8 ESP 80-17	17	63.00	85.00		348	336	319	297	274	252	230	205	170	124
8 ESP 80-18	18	63.00	85.00		369	356	338	314	290	267	244	217	180	131
8 ESP 80-19	19	75.00	100.0		390	375	356	332	306	282	257	229	190	139
8 ESP 80-20	20	75.00	100.0		410	395	375	349	322	297	271	241	200	146

جدول وزن و ابعاد پمپ سری 8ESP 80,50Hz

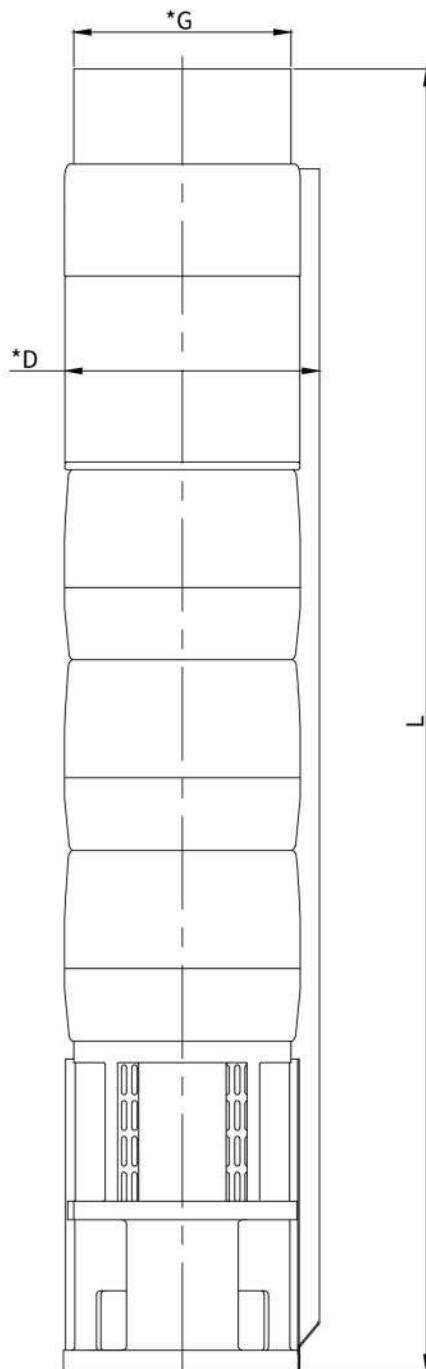

MODEL	SPECIFICATION			
	D* (mm)	D** (mm)	L (mm)	PUMP WEIGHT (in Kg.)
8 ESP 80 - 01	175	180	620	21
8 ESP 80 - 02	175	180	748	25
8 ESP 80 - 03	175	180	876	29
8 ESP 80 - 04	175	180	1004	33
8 ESP 80 - 05	175	180	1132	37
8 ESP 80 - 06	175	180	1260	41
8 ESP 80 - 07	175	180	1388	45
8 ESP 80 - 08	175	180	1516	49
8 ESP 80 - 09	175	180	1644	53
8 ESP 80 - 10	175	180	1772	55
8 ESP 80 - 11	175	180	1900	59
8 ESP 80 - 12	196	200	2028	63
8 ESP 80 - 13	196	200	2156	67
8 ESP 80 - 14	196	200	2284	71
8 ESP 80 - 15	196	200	2412	75
8 ESP 80 - 16	196	200	2540	79
8 ESP 80 - 17	196	200	2668	83
8 ESP 80 - 18	196	200	2796	87
8 ESP 80 - 19	196	200	2924	91
8 ESP 80 - 20	196	200	3052	95

* G: Available Outlet Size BSP 5"

* D: Maximum Diameter With Single Cable Guard

** D: Maximum Diameter With Double Cable Guard
upto 50 HP 6" Motor Joining

8VP 80 -01 to 8VP 80 -11 pump are available in 6" joining

8VP 80 -12 to 8VP 80 -20 pump are available in 8" joining

منحنی عملکرد پمپ سری 8ESP 98,50Hz

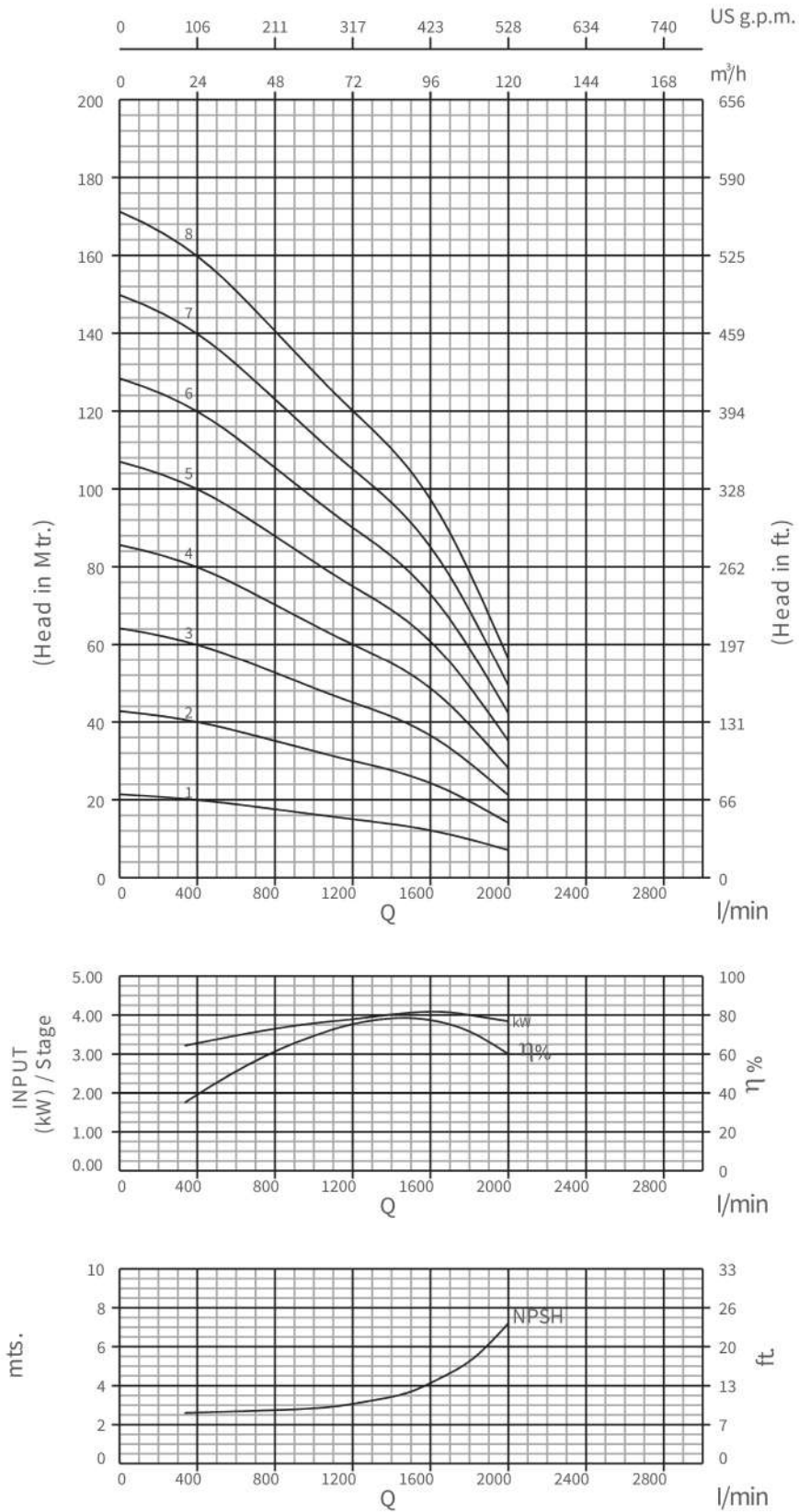

منحنی عملکرد پمپ سری 8ESP 98,50Hz

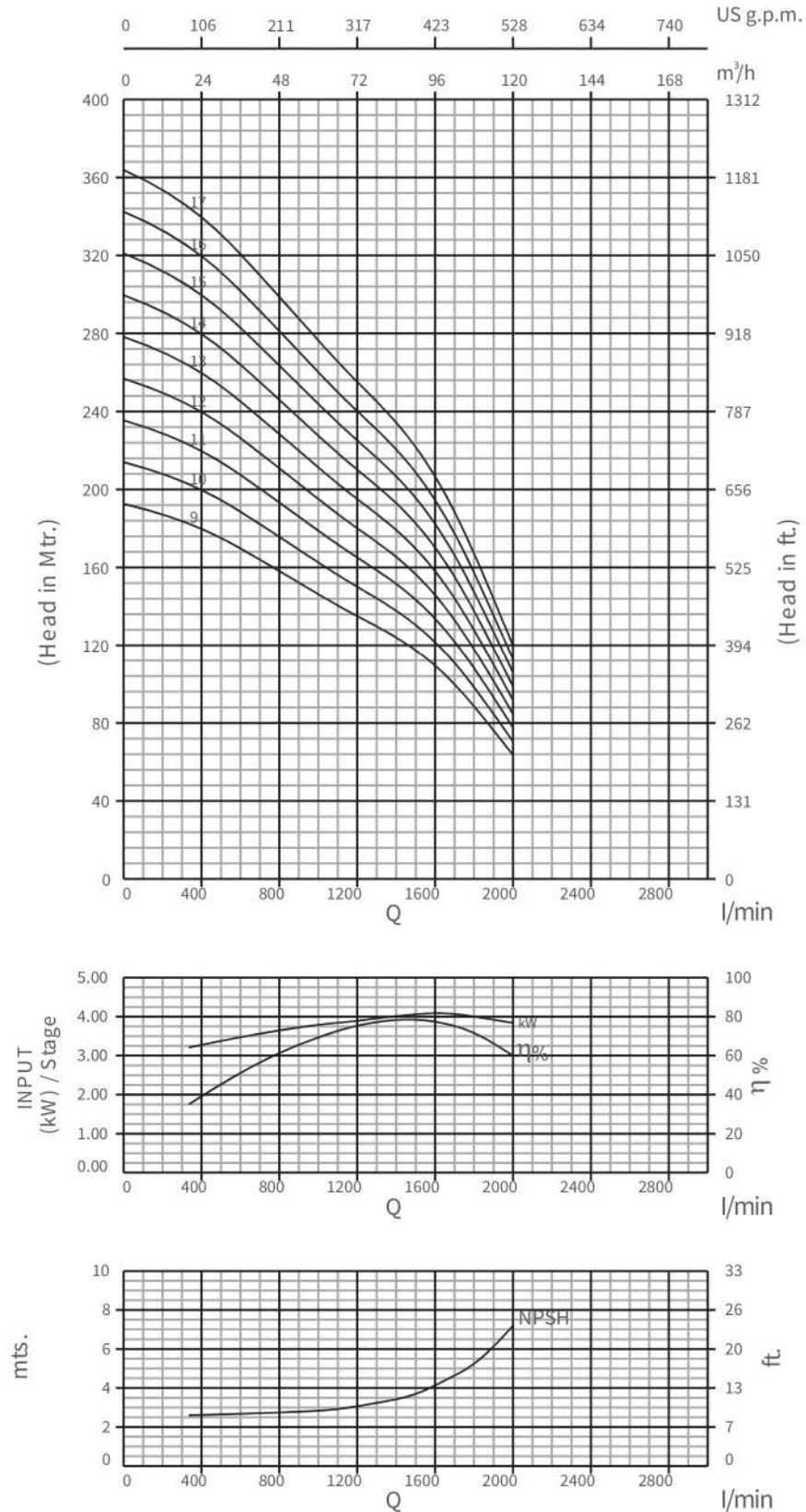

جدول عملکرد پمپ سری 8ESP 98,50Hz

Model Name	Stage	Rating		l/min m ³ /h	Discharge									
		kW	HP		0	335	675	1010	1170	1335	1500	1670	1835	2000
Three Phase					0	20.0	40.5	60.6	70.2	80.1	90.0	100.2	110.1	120.0

Model Name	Stage	kW	HP	HEAD IN Mtrs.	0	335	675	1010	1170	1335	1500	1670	1835	2000
8 ESP 98-01	1	5.50	7.50	21.5	21	18	16	15	14	13	12	9	7	
8 ESP 98-02	2	9.30	12.50	43	41	37	32	30	28	26	23	19	14	
8 ESP 98-03	3	13.00	17.50	64	62	55	49	46	43	39	35	28	21	
8 ESP 98-04	4	18.50	25.00	86	82	74	65	61	57	52	46	38	28	
8 ESP 98-05	5	22.00	30.00	107	103	92	81	76	71	66	58	47	35	
8 ESP 98-06	6	26.00	35.00	128	123	110	97	91	85	79	69	56	42	
8 ESP 98-07	7	30.00	40.00	150	144	129	113	106	100	92	81	66	49	
8 ESP 98-08	8	37.00	50.00	171	164	147	129	121	114	105	92	75	56	
8 ESP 98-09	9	37.00	50.00	193	185	166	146	137	128	118	104	85	63	
8 ESP 98-10	10	45.00	60.00	214	205	184	162	152	142	131	115	94	70	
8 ESP 98-11	11	55.00	75.00	235	226	203	178	167	157	144	127	104	78	
8 ESP 98-12	12	55.00	75.00	257	246	221	194	182	171	157	138	113	85	
8 ESP 98-13	13	55.00	75.00	278	267	239	210	197	185	171	150	122	92	
8 ESP 98-14	14	63.00	85.00	300	287	258	227	212	199	184	161	132	99	
8 ESP 98-15	15	75.00	100.0	321	308	276	243	228	213	197	173	141	106	
8 ESP 98-16	16	75.00	100.0	342	328	295	259	243	228	210	184	151	113	
8 ESP 98-17	17	75.00	100.0	364	349	313	275	258	242	223	196	160	120	

جدول عملکرد پمپ سری 8ESP 98,50Hz

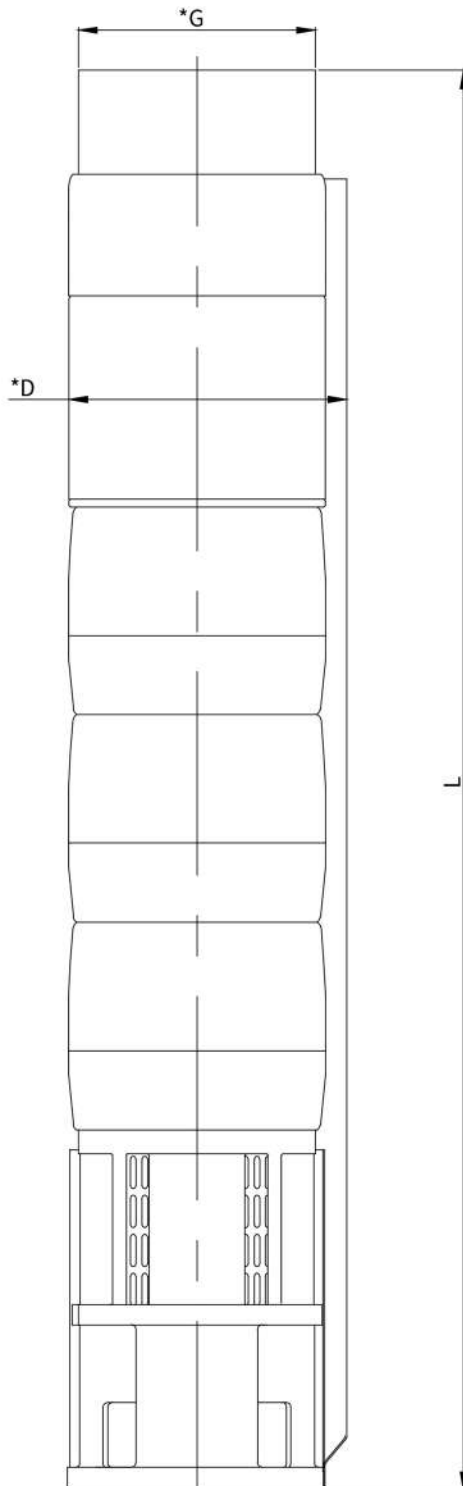

MODEL	SPECIFICATION			
	D* (mm)	D** (mm)	L (mm)	PUMP WEIGHT (in Kg.)
8 ESP 98 - 01	175	180	620	21
8 ESP 98 - 02	175	180	748	25
8 ESP 98 - 03	175	180	876	29
8 ESP 98 - 04	175	180	1004	33
8 ESP 98 - 05	175	180	1132	37
8 ESP 98 - 06	175	180	1260	41
8 ESP 98 - 07	175	180	1388	45
8 ESP 98 - 08	175	180	1516	49
8 ESP 98 - 09	175	180	1644	53
8 ESP 98 - 10	196	200	1772	55
8 ESP 98 - 11	196	200	1900	59
8 ESP 98 - 12	196	200	2028	63
8 ESP 98 - 13	196	200	2156	67
8 ESP 98 - 14	196	200	2284	71
8 ESP 98 - 15	196	200	2412	75
8 ESP 98 - 16	196	200	2540	79
8 ESP 98 - 17	196	200	2668	83

* G: Available Outlet Size BSP 5"

* D: Maximum Diameter With Single Cable Guard

** D: Maximum Diameter With Double Cable Guard
upto 50 HP 6" Motor Joining

8VP 98 - 01 to 8VP 98 - 09 pump are available in 6" joining

8VP 98-10 to 8VP 98 -17 pump are available in 8" joining

جدول مشخصات پمپ سری 10ESP 128

NO	PART NAME	MATERIAL	STANDARD
1	BOWL / DIFFUSER	STAINLESS STEEL	304
2	IMPELLER	STAINLESS STEEL	304
3	NECK RING	NBR	
4	SHAFT	STAINLESS STEEL	431
5	COUPLE	STAINLESS STEEL	316
6	DELIVERY CASING	STAINLESS STEEL	304
7	SUCTION CASE	STAINLESS STEEL	304
8	BEARING BUSH	NBR	
9	STRAINER	STAINLESS STEEL	304

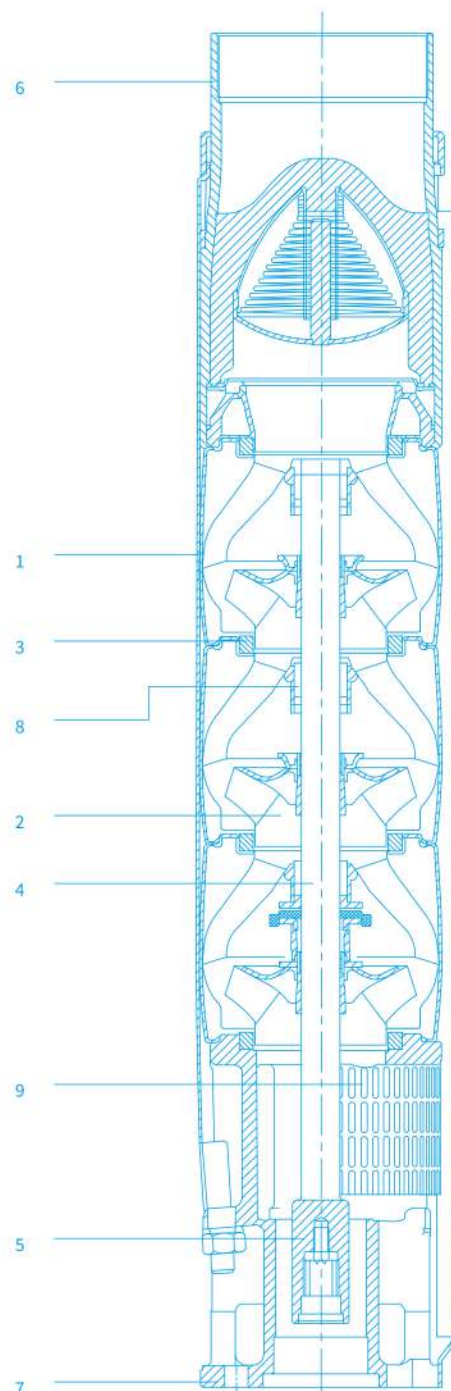

منحنی عملکرد پمپ سری 10ESP 128,50Hz

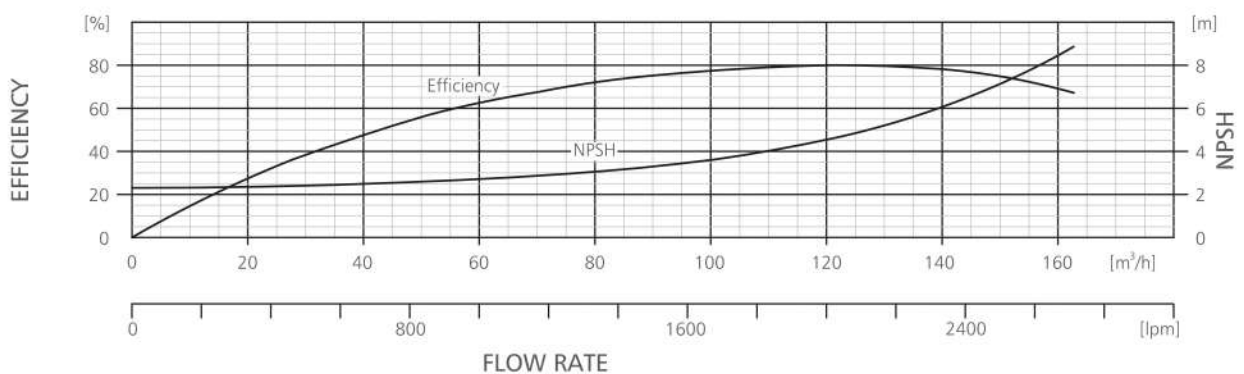
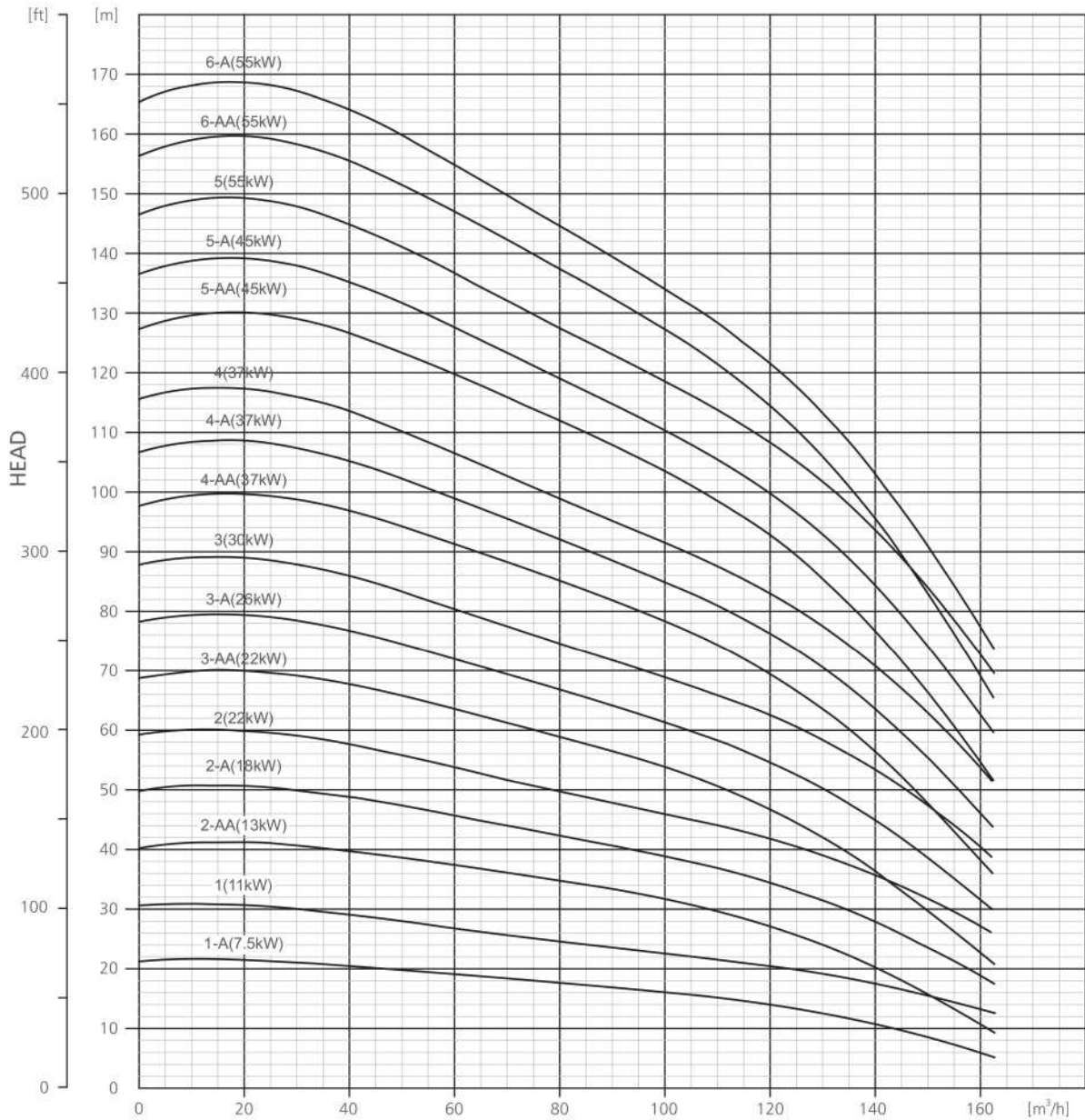

منحنی عملکرد پمپ سری 10ESP 128,50Hz

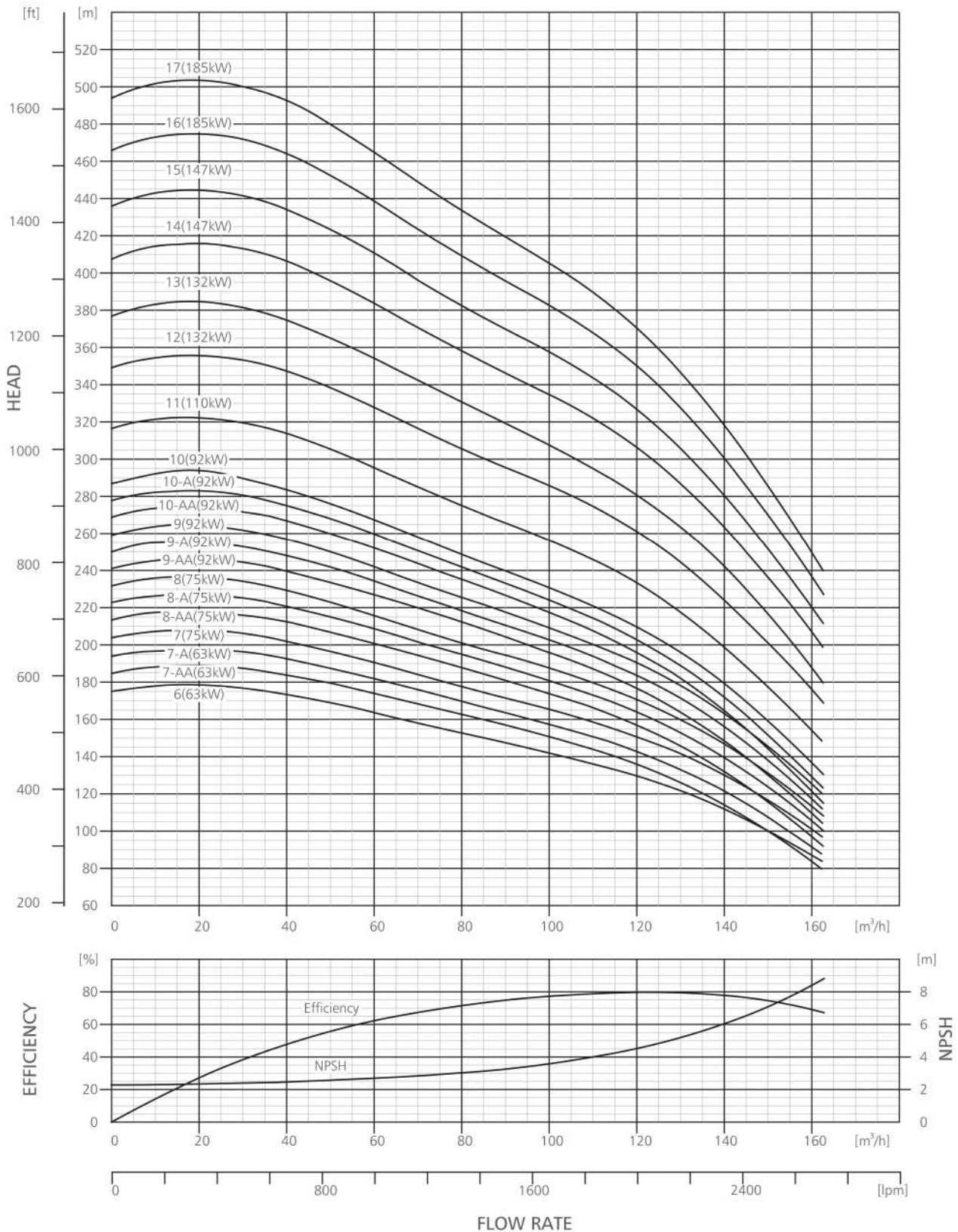

جدول عملکرد پمپ سری 10ESP 128,50Hz

Model Name	Rating		Discharge													
	kW	HP	l/min	0	60	70	80	90	100	110	120	130	140	150	160	
			m ³ /h	0	1000	1167	1333	1500	1667	1833	2000	2167	2333	2500	2667	2700

Model Name	Rating kW	Rating HP	HEAD IN Mtrs.													
			21	19	18	17	17	16	15	14	12	10	8	6	5	
10ESP-128-1-A	7.5	10	21	19	18	17	17	16	15	14	12	10	8	6	5	
10ESP-128-1	11	15	30	27	25	24	23	22	21	20	19	17	15	13	12	
10ESP-128-2-AA	13	17.5	40	37	36	35	33	31	29	27	24	20	16	11	10	
10ESP-128-2-A	18.5	25	50	45	44	42	40	39	37	34	31	28	23	19	18	
10ESP-128-2	22	30	59	54	52	50	48	46	44	42	39	35	32	27	26	
10ESP-128-3-AA	22	30	69	63	61	59	56	54	50	47	42	36	30	22	21	
10ESP-128-3-A	26	35	78	72	69	67	64	61	58	54	50	45	38	31	30	
10ESP-128-3	30	40	88	80	77	74	72	69	66	62	58	53	47	40	39	
10ESP-128-4-AA	37	50	98	91	88	85	82	78	74	69	63	56	48	38	36	
10ESP-128-4-A	37	50	107	99	95	92	88	85	81	76	70	63	55	46	44	
10ESP-128-4	37	50	116	106	102	99	95	91	87	83	77	71	63	54	52	
10ESP-128-5-AA	45	60	127	120	116	112	108	103	98	93	85	77	66	54	52	
10ESP-128-5-A	45	60	136	127	123	119	115	110	105	100	93	84	74	63	60	
10ESP-128-5	55	75	146	137	132	127	123	118	114	108	102	93	84	72	70	
10ESP-128-6-AA	55	75	156	147	142	137	132	127	121	114	106	95	83	69	66	
10ESP-128-6-A	55	75	165	155	150	144	139	134	128	121	113	103	91	77	74	
10ESP-128-6	63	85	175	164	158	153	147	142	136	130	122	112	100	87	84	
10ESP-128-7-AA	63	85	185	174	168	163	157	151	144	136	126	114	100	83	80	
10ESP-128-7-A	63	85	194	182	176	170	164	158	151	143	133	122	107	92	88	
10ESP-128-7	75	100	204	191	184	178	172	165	159	151	142	130	117	101	97	
10ESP-128-8-AA	75	100	214	201	194	188	181	174	166	157	146	132	116	97	93	
10ESP-128-8-A	75	100	223	209	202	195	188	181	173	164	153	139	123	105	101	
10ESP-128-8	75	100	232	216	209	202	195	188	180	171	160	147	131	113	109	
10ESP-128-9-AA	93	125	241	227	219	212	204	196	187	177	164	149	130	110	105	
10ESP-128-9-A	93	125	250	234	226	219	211	203	194	184	171	156	138	117	113	
10ESP-128-9	93	125	260	242	234	226	218	209	201	191	178	163	146	125	121	
10ESP-128-10-AA	93	125	269	252	244	235	227	218	208	196	182	165	144	121	117	
10ESP-128-10-A	93	125	278	260	251	242	233	224	214	203	189	172	152	129	124	
10ESP-128-10	93	125	287	267	258	249	240	231	221	210	196	179	159	137	132	



دریایی و کشتی سازی



شیمیایی، غذا و دارو



آتش نشانی



ساختمانی و شهری



معدن فولاد و مس



صنایع نیروگاهی



نفت، گاز و پتروشیمی



آب، فاضلاب و کشاورزی

www.Espadanpump.ir

دفتر مرکزی : اصفهان . چهارراه حکیم نظامی
روبروی . باشگاه هواداران سپاهان . پلاک ۲۰۴
تلفن : ۰۳۱-۳۶۲۴۷۰۱۷
تلفکس : ۰۳۱-۳۶۲۴۷۱۰۴

کارخانه : اصفهان . شهرک صنعتی نجف آباد ۲
بلوار امیرکبیر . نیش فرعی ۱۶ . پلاک ۲۲
تلفن : ۰۳۱-۴۲۶۹۵۰۶۲
تلفکس : ۰۳۱-۴۲۶۹۵۰۶۳